



Affordable Elegance



Faucets & Specialties



October • 2006

MATCO-NORCA

ALWAYS GROWING, ALWAYS CHANGING, ALWAYS SOMETHING NEW!



Brewster, NY - Headquarters

MATCO-NORCA began in 1952, as the pioneer import distributor of plumbing products. Since then, MATCO-NORCA has grown to be the largest, independent distributor of malleable fittings, steel nipples, valves and plumbing specialties in the U.S. Throughout the years we have established ourselves as a leader with a products line that boasts superior quality and value.

A commitment to large inventories and customer service at a local level is what sets MATCO-NORCA apart from the rest of the field. With over 400,000 square feet of inventory located across the U.S., our line of products is second to none in depth and range. National distribution centers in New York, Texas, California, and Georgia as well as regional warehouses in Chicago, Denver, Dallas, Tampa, and Northern California assures our customers that products are always readily available to ship at your request.



Americus, Georgia

Have a technical question? Our trained and knowledgeable staff offers the latest, up-to-date product information to keep you in-tune with all the new products and design application trends. Call us toll free and ask us about our new job packs.

MATCO-NORCA brings a highly specialized and unique approach to global sourcing and product distribution. We have professional inspectors in overseas that audit and inspect all of our product lines. Each factory is certified to the International ISO-9002 Quality System Standards. All products must meet strict requirements and are carefully tested to industry standards prior to shipment.

Our entire MATCO-NORCA family is constantly searching for new ways to bring extra value to our customers. This is evident in the exciting new product introductions that continue to keep MATCO-NORCA on the cutting edge

of our industry. A good example of this is our new line of "Affordable Elegance" faucets which brings the best European and American styles to market at affordable prices that guarantee exceptional value.

Our primary focus is in servicing the wholesale customer and enabling you to "build your business around ours." This allows us to focus on backing local businesses, ensuring that our support allows their future prosperity.

Due to the diversity of our product line, a Valves & Specialties Catalog as well as the Waterworks & Irrigation 2004 Catalog only is available to compliment this Faucet & Specialties Catalog. They cover brass, bronze, and PVC valves including gate valves, ball valves, check valves, heating and gas valves, pump & well products, clamps, couplings and other specialties along with our full line of cast iron valves, flanges & connecting hardware from 2" through 24". The final piece in our new trilogy is this "Faucets & Plumbing Specialties" Catalog which is packed with everything a plumbing wholesaler needs to supply to the finished side of the wall!

Our dedicated team at MATCO-NORCA is committed to your success. We encourage you to give us a call today, toll free, and have our new catalogs sent out to you right away. You can also visit or contact us on the web at www.matco-norca.com.



Houston, Texas



La Palma, California

• TABLE OF CONTENTS •

A

Aerator 32
Air gap 53

B

Bar faucets 12, 23, 24, 30
Bathcock - clawfoot tubs 46
Bath accessories 25, 27, 36
Bath drains 56
Bath spouts 20, 37
Bath waste & overflow 54, 55
Bidet 22

C

Closet bends 57
Closet flanges 57
Closet spuds 56

Collections

Classic Elegance

kitchen 4
bathroom 5

Crescendo

kitchen 26
bath 27
accessories 27

Napoli

kitchen 23
bath 23

Portia

kitchen 24
bath 24, 25
accessories 25

Positano

kitchen 21
bath 21

Padova

kitchen 28
bath 28, 29
accessories 29

Ravello

kitchen 22
bath 22

D

Dishwasher tail pieces 53
Dishwasher accessories 53
Diverters 39
Drinking fountains 32, 33
Drop ear elbow 45

F

Faucets
bar 12, 23, 24, 30
bidet 22
drinking water 32, 33

F - cont'd.

Faucets - cont'd.
handle options 30
heavy duty 30
kitchen 12, 14, 18, 21, 22, 23,
24, 26, 28, 30, 31, 32
lavatory ... 13, 15, 19, 21, 22, 23
24, 25, 26, 28, 31
laundry 30
non-metallic 31
pressure balanced 16, 20, 23, 27
restaurant quality 30
roman bath fillers ... 13, 21, 22, 23
25, 26, 28, 29, 30
seats & trim 39
self closing faucets 33
self closing valves 33
stem options 39
wall mounts 30
Flanges 57

H

Handles 38
Hose bibs 47
Hose & spray 32
Hoses 36, 40

I

Integral stops - slotted 32

J

Job packs - **NEW!** 18-19

K

Kitchen faucets 12, 14, 18, 21,
22, 23, 24, 26, 28, 30, 31, 32
Kitchen wall mount 30

L

Laundry faucets 30
Lavatory faucets 13, 15, 19, 21,
22, 23, 24, 25, 26, 28, 31

P

Pop-ups & sink drains 44
PVC - flexible sink drains 59
Plumber's tool 32

R

Restaurant quality 30
Roman bath faucets 13, 21, 22,
23, 25, 26, 28, 29, 30

S

Saddle valves 54
Self closing valves 33
Service sink faucets 30
Shower ... 16, 17, 21, 22, 23, 25, 27
29, 30, 40
Shower accessories 36

S - cont'd.

Shower heads ... 20, 29, 33, 34, 35
hand held 35
accessories 25, 27, 36
sunflower 33, 34
Shower drains 45
Shower stall valves 40
Shower valves 32, 36, 40
Shower valve stems options 40
Shower drains 45
Single basin faucets 46
Sink drains 44, 59
Sink strainers 41-44
Slip nuts 59
Soap dispensers 32
Spuds 56
Standing waste 56
Stems 39
Strainers 41-44
replacement inserts 43
Supply Hoses
stainless steel 40
delta style 40
economy for sink 40
economy for closet 40
dishwasher - 90° elbow 40
Supply Valves
quarter turn 48, 49
angled 48, 49
pex 50
oval handles - 1/4 turn
straight 49, 50
pex 49, 50
angled 50
dual valve 51
compression
pex tube 51
angled 51
straight 52
dual outlet - angled 52
flare outlet - angled 52
Multi-turn
economy - angled 51

T

Terms of Sale 61
Toilet tank trim 54
Tools - socket wrenches 32
Traps 58, 59
Tub spouts 20, 37
Twin Mix Connectors 53

U

Urinal spuds 56
Utility shower 40

W

Warranties 60-61
Washing machine tees 53
Washing machine valves 53

classic elegance

K I T C H E N

Style with a sense of rhythm. Our Classic Elegance Kitchen faucets continue a tradition of unique features with extraordinary value! Call Matco-Norca's Customer Service Dept. today!



**Kitchen Faucet
AE-251**

PULL-OUT SPRAY!



**Kitchen Faucet
with spray FT-310**



**Kitchen Faucet
with spray FT-210SEL**

Kitchen faucets with spray
are also available in **NEW**
job packs! See pages 18-20.



**Kitchen Faucet
FT-900**

classic elegance

S H O W E R & B A T H

Bathroom fittings are an opportunity for a design statement. Matco-Norca's Classic Elegance Collection brings that statement into the home economically and with style.



**Bath & Shower
TNS-100PBWSL**



**Roman Bath Filler
RT-151**



Shower & bath fittings are also available in **NEW** job packs! See pages 18-20.



**Lavatory Faucet
CT-452**



**Lavatory Faucet
CT-452SEL**



**Lavatory Faucet
CT-452D**



**Lavatory Faucet
CT-852**



positano

Make a style statement! Reminiscent of a past elegance, the Positano line is crisp & timeless. Easy to keep clean with bold strokes of emphasis. A perfect fit!

**Kitchen Faucet
with spray
AE-915**



**Bath & Shower
AE-100PBW**



**Lavatory Widespread
AE-150**



**Roman Bath Filler
AE-151**



**Lavatory Faucet
AE-855**

ravello

The Ravello collection boasts smooth lines with accented angles. You can feel the basic functionality of the faucet yet an element of style comes tastefully through. Perfect accents with noticeable elegance!

**Roman Bath Filler
with spray
AE-187**



**Kitchen Faucet with spray
AE-366**



**Lavatory Widespread
AE-185**



Bidet AE-440



**Lavatory Faucet
AE-885**



Lavatory Faucet AE-495



**Bar Faucet
AE-930**



**Kitchen Faucet
with spray AE-315**



napoli

Understated elegance, a sleek flow and crisp base lines.
Keep a unique look to your running water without breaking
the bank. Matco-Norca brings great design home!



**Lavatory Widespread
AE-135**



**Roman Bath Filler
AE-136**



**Bath & Shower
AE-100PBW**

Bar Faucet AE-360



**Kitchen Faucet
with spray AE-965**



**Lavatory Faucet
AE-835**

portia



**Lavatory Widespread
AE-165**



**Lavatory
Faucet
AE-865**

The Portia Collection has its' design roots in the past but with performance built for today. Flowing lines enhance the concept of flowing water. Let Matco's Portia Collection put that "look" in your bar, bathroom or kitchen!

**Bar Faucet
AE-325**



**Roman Bath Filler
AE-155**



PULL-OUT SPRAY!



**Bath & Shower
AE-105PBW**



**Kitchen Faucet
AE-255**



**Kitchen Faucet
with spray AE-925**

**Bar Faucet
AE-956**



**Kitchen Faucet
with spray AE-955**

crescendo

**Lavatory Widespread
AE-175**



**Lavatory Faucet
AE-875**



Sophisticated elegance. A direct statement of refinement and luxury. Say it with confidence throughout your home with Crescendo. Matco supplies top shelf affordability!

**Bath & Shower
AE-110PBW**



**Kitchen Faucet with spray
AE-945**



**Kitchen Faucet
with spray
AE-935**



Roman Bath Filler AE-176



padova



Beautiful design with a simple stated elegance in straight lines. Angled handles and unique bends offer your home that clean, elegant look!



**Lavatory
Faucet
AE-895**



**Bath & Shower
AE-115PBW**



Kitchen Faucet with spray AE-195



**Kitchen
Faucet
with
spray
AE-295**



**Glass Vessel
Style Faucet
AE-970**



Lavatory Widespread AE-995



Roman Bath Filler AE-985



Roman Bath Filler with spray AE-986









IMAGE	DESCRIPTION	MODEL NO. / FINISH	INNER	MASTER
	<p>CLASSIC ELEGANCE <i>KITCHEN FAUCET</i></p> <ul style="list-style-type: none"> • washerless cartridge • 8" centerset • single lever metal handle • with spray 	<p>FT - 210 - AS SHOWN</p> <p>FT - 200 - LESS SPRAY</p>	<p>1</p> <p>1</p>	<p>6</p> <p>6</p>
JOB PACKS AVAILABLE - SEE PAGES 18 - 20				
	<p>CLASSIC ELEGANCE <i>KITCHEN FAUCET</i></p> <ul style="list-style-type: none"> • washerless cartridge • 8" centerset • single lever metal handle • with spray on deck 	<p>FT - 210D - AS SHOWN</p>	<p>1</p>	<p>6</p>
	<p>CLASSIC ELEGANCE <i>KITCHEN FAUCET</i></p> <ul style="list-style-type: none"> • washerless cartridge • 8" centerset • two acrylic handles 	<p>FT - 300 - AS SHOWN</p> <p>FT - 310 - WITH SPRAY</p>	<p>1</p> <p>1</p>	<p>6</p> <p>6</p>
JOB PACKS AVAILABLE - SEE PAGES 18 - 20				
	<p>CLASSIC ELEGANCE <i>KITCHEN FAUCET</i></p> <ul style="list-style-type: none"> • washerless cartridge • 8" centerset • two wrist blade handles • less spray 	<p>FT - 300WB - AS SHOWN</p>	<p>1</p>	<p>12</p>
	<p>CLASSIC ELEGANCE <i>KITCHEN FAUCET</i></p> <ul style="list-style-type: none"> • washerless cartridge • 8" centerset • two acrylic handles • high spout 	<p>FT - 900 - AS SHOWN</p> <p>FT - 910 - WITH SPRAY</p> <p>FT - 910ED3 - AS SHOWN + INCLUDES</p> <p>3 HANDLE STYLES: ACRYLIC - OAK - WHITE</p>	<p>1</p> <p>1</p> <p>1</p>	<p>12</p> <p>12</p> <p>12</p>
	<p>CLASSIC ELEGANCE <i>KITCHEN FAUCET</i></p> <ul style="list-style-type: none"> • washerless cartridge • 8" centerset • two white lever handles • high spout 	<p>FT - 900WL - AS SHOWN</p> <p>FT - 910WL - WITH SPRAY</p>	<p>1</p> <p>1</p>	<p>12</p> <p>12</p>
	<p>CLASSIC ELEGANCE <i>BAR FAUCET</i></p> <ul style="list-style-type: none"> • 4" centerset • metal handles • goose neck spout • also available with wrist blade handles 	<p>FY - 990 - AS SHOWN</p> <p>FY - 991WB - WRIST BLADE HANDLES</p>	<p>1</p> <p>1</p>	<p>24</p> <p>12</p>
	<p>CLASSIC ELEGANCE <i>KITCHEN FAUCET</i></p> <ul style="list-style-type: none"> • compression • 8" centerset • two handle • solid cast brass spout • Gerber style, heavy pattern • less spray 	<p>FT - 777 - AS SHOWN</p> <p>FT - 700 - LESS SPRAY</p>	<p>1</p> <p>1</p>	<p>24</p> <p>24</p>

IMAGE	DESCRIPTION	MODEL NO. / FINISH	INNER	MASTER
	<p>CLASSIC ELEGANCE <i>LAVATORY FAUCET</i></p> <ul style="list-style-type: none"> • washerless cartridge • 4" centerset • single acrylic handle • with brass pop-up 	CT - 452 - AS SHOWN	1	12
		CT - 400 - LESS POP-UP	1	12
JOB PACKS AVAILABLE - SEE PAGES 18 - 20				
	<p>CLASSIC ELEGANCE <i>LAVATORY FAUCET</i></p> <ul style="list-style-type: none"> • washerless cartridge • single handle • 4" centerset • metal lever handle • with brass pop-up 	CT - 452D - AS SHOWN	1	12
		CT - 400D - LESS POP-UP	1	12
JOB PACKS AVAILABLE - SEE PAGES 18 - 20				
	<p>CLASSIC ELEGANCE <i>LAVATORY FAUCET</i></p> <ul style="list-style-type: none"> • washerless cartridge • 4" centerset • two acrylic handles • with brass pop-up 	CT - 852 - AS SHOWN	1	12
		CT - 800 - LESS POP-UP	1	12
JOB PACKS AVAILABLE - SEE PAGES 18 - 20				
	<p>CLASSIC ELEGANCE <i>LAVATORY FAUCET</i></p> <ul style="list-style-type: none"> • washerless cartridge • 4" centerset • two wrist blade handles • less pop-up 	CT - 800WB - AS SHOWN	1	12
		JOB PACKS AVAILABLE - SEE PAGES 18 - 20		
	<p>CLASSIC ELEGANCE <i>LAVATORY FAUCET</i></p> <ul style="list-style-type: none"> • compression • 4" centerset • two rounded metal handles 	CT - 705 - LESS POP-UP	1	12
		CT - 750 - WITH POP-UP	1	12
	<p>CLASSIC ELEGANCE <i>LAVATORY FAUCET</i></p> <ul style="list-style-type: none"> • compression • 4" centerset • two metal brass wrist blade handles • Gerber style 	CT - 777WB - AS SHOWN		
		CT - 777 - LEVER GERBER STYLE HANDLES - WITH POP-UP	1	12
	<p>CLASSIC ELEGANCE <i>WIDESPREAD LAVATORY FAUCET</i></p> <ul style="list-style-type: none"> • washerless cartridge • chrome plated widespread • acrylic handles • brass pop-up 	CT - 150 - AS SHOWN	1	12
	<p>CLASSIC ELEGANCE <i>ROMAN BATH FILLER</i></p> <ul style="list-style-type: none"> • washerless cartridge • chrome plated widespread • two XL acrylic handles • rough-in body • slip fit spout (9") and trim 	RT - 151 - AS SHOWN	1	12







IMAGE	DESCRIPTION	MODEL NO. / FINISH	INNER	MASTER
	<p>CLASSIC ELEGANCE EURO <i>KITCHEN FAUCET - PULLOUT</i></p> <ul style="list-style-type: none"> • ceramic cartridge • 8" centerset • metal lever handle • pullout spray 	AE - 251 - AS SHOWN	1	12
		AE - 251S - BRUSHED NICKEL	1	12
	<p>CLASSIC ELEGANCE EURO <i>KITCHEN FAUCET</i></p> <ul style="list-style-type: none"> • washerless cartridge • 8" centerset • solid single lever handle • with spray 	FT - 210SEL - AS SHOWN	1	12
		FT - 200SEL - CHROME - LESS SPRAY	1	12
		FT - 210SELS - BRUSHED NICKEL WITH SPRAY	1	12
		FT - 200SELS - BRUSHED NICKEL LESS SPRAY	1	12
	<p>CLASSIC ELEGANCE EURO <i>KITCHEN FAUCET</i></p> <ul style="list-style-type: none"> • washerless cartridge • 8" centerset • solid single lever handle • with hose & spray • with 20" supply hose attached 	FT - 210SELSH - AS SHOWN	1	12
				
	<p>CLASSIC ELEGANCE EURO <i>KITCHEN FAUCET</i></p> <ul style="list-style-type: none"> • washerless cartridge • 8" centerset • two acrylic handles • with spray 	FT - 310ED - AS SHOWN	1	6
		FT - 300ED - LESS SPRAY	1	6
	<p>CLASSIC ELEGANCE EURO <i>KITCHEN FAUCET</i></p> <ul style="list-style-type: none"> • washerless cartridge • 8" centerset • two rounded metal handles • with spray 	FT - 305ED - AS SHOWN	1	6
		FT - 315ED - WITH SPRAY	1	6
	<p>CLASSIC ELEGANCE EURO <i>KITCHEN FAUCET</i></p> <ul style="list-style-type: none"> • washerless cartridge • 8" centerset • two lever handles • with spray • 3 styles of decorator handles included: acrylic - oak - white 	FT - 310ED3 - AS SHOWN	1	12
		FT - 300ED3 - LESS SPRAY	1	12













IMAGE	DESCRIPTION	MODEL NO. / FINISH	INNER	MASTER
	<p>CLASSIC ELEGANCE EURO LAVATORY FAUCET</p> <ul style="list-style-type: none"> • washerless cartridge • 4" centerset • solid single lever • brass pop-up 	CT - 452SEL - AS SHOWN	1	12
		CT - 400SEL - LESS POP-UP	1	12
		CT - 452SELS - BRUSHED NICKEL WITH SPRAY	1	12
		CT - 400SELS - BRUSHED NICKEL LESS SPRAY	1	12
		 JOB PACKS AVAILABLE - SEE PAGES 18 - 20		
	<p>CLASSIC ELEGANCE EURO LAVATORY FAUCET</p> <ul style="list-style-type: none"> • washerless cartridge • 4" centerset • solid single lever • brass pop-up • with 20" supply hose attached 	CT - 452SELSH - AS SHOWN	1	12
				
	<p>CLASSIC ELEGANCE EURO LAVATORY FAUCET</p> <ul style="list-style-type: none"> • washerless cartridge • 4" centerset • two acrylic handles • brass pop-up 	CT - 852ED - AS SHOWN	1	12
		CT - 800ED - LESS POP-UP	1	12
		 JOB PACKS AVAILABLE - SEE PAGES 18 - 20		
	<p>CLASSIC ELEGANCE EURO LAVATORY FAUCET</p> <ul style="list-style-type: none"> • washerless cartridge • 4" centerset • two handles • 3 styles of decorator handles included: acrylic - oak - white 	CT - 852ED3 - AS SHOWN	1	12
				
	<p>CLASSIC ELEGANCE EURO LAVATORY FAUCET</p> <ul style="list-style-type: none"> • washerless cartridge • 4" centerset • two wrist blade handles • less pop-up 	CT - 800EDWB - AS SHOWN	1	12
				
	<p>CLASSIC ELEGANCE EURO LAVATORY FAUCET</p> <ul style="list-style-type: none"> • washerless cartridge • 4" centerset • two rounded metal handles • brass pop-up 	CT - 855ED - AS SHOWN	1	12
		CT - 805ED - LESS POP-UP	1	12
				







IMAGE	DESCRIPTION	MODEL NO. / FINISH	INNER	MASTER
	<p>CLASSIC ELEGANCE EURO <i>BATH AND SHOWER SET - CHROME</i></p> <ul style="list-style-type: none"> • washerless cartridge • pressure balancing valve • solid lever handle • integral stops • massage shower head • diverter spout - IPS connection • valve & trim available 	TNS - 100PBWSL - BATH & SHOWER	1	8
		TNS - 100SPBWSL - SHOWER ONLY	1	8
		TNS - 100PBWSLS - BATH & SHOWER - BRUSHER NICKEL	1	8
		TNS - 100SPBWSLS - SHOWER ONLY	1	8
		TNS - 100PBWCSL - BATH & SHOWER SWEAT CONNECT	1	8
JOB PACKS AVAILABLE - SEE PAGES 18 - 20				
	<p>CLASSIC ELEGANCE EURO <i>BATH AND SHOWER SET - CHROME</i></p> <ul style="list-style-type: none"> • ceramic cartridge • pressure balancing valve • solid lever handle • integral stops • chrome plated brass shower arm • massage shower head • diverter spout - IPS connection 	TNS - 100PBSL - AS SHOWN	1	8
		TNS - 100SPBSL - SHOWER ONLY	1	8
		TNS - 100PBCSL - SWEAT CONNECT	1	8
		TNS - 100SPBCSL - SHOWER ONLY SWEAT CONNECT	1	8
	<p>CLASSIC ELEGANCE <i>BATH AND SHOWER SET - CHROME</i></p> <ul style="list-style-type: none"> • washerless cartridge • chrome plated brass arm & head • single acrylic handle • threaded diecast diverter spout - IPS connection 	TNS - 100 - AS SHOWN	1	8
	<p>CLASSIC ELEGANCE <i>SHOWER ONLY</i></p> <ul style="list-style-type: none"> • shower only • washerless cartridge • single acrylic handle • chrome plated brass arm & head 	TNS - 100S - AS SHOWN	1	8
	<p>CLASSIC ELEGANCE <i>BATH AND SHOWER SET - CHROME</i></p> <ul style="list-style-type: none"> • washerless cartridge • chrome plated brass arm & head • single metal handle • diverter spout - IPS connection 	TNS - 100D - AS SHOWN	1	8
	<p>CLASSIC ELEGANCE <i>BATH AND SHOWER SET - CHROME</i></p> <ul style="list-style-type: none"> • washerless cartridge • two acrylic handles • chrome plated ABS shower head, arm & flange • diverter spout - IPS connection 	TNS - 782WS - AS SHOWN	1	6
	<p>CLASSIC ELEGANCE <i>BATH FILLER AND HANDLE SET</i></p> <ul style="list-style-type: none"> • washerless cartridge • two acrylic handles • chrome plated over rim diverter spout - IPS connection 	TNS - 782TWS - AS SHOWN	1	6







IMAGE	DESCRIPTION	MODEL NO. / FINISH	INNER MASTER
	<p>CLASSIC ELEGANCE <i>SHOWER ONLY</i></p> <ul style="list-style-type: none"> • washerless cartridge • two acrylic handles • chrome plated ABS shower head, arm & flange 	<p>TNS - 782SWS - AS SHOWN</p>	<p>1 6</p>
	<p>CLASSIC ELEGANCE <i>BATH AND SHOWER SET</i></p> <ul style="list-style-type: none"> • washerless cartridge • chrome plated die cast spout • three acrylic handles (diverter) • chrome plated ABS shower head, arm & flange • IPS connection 	<p>TNS - 783WS - AS SHOWN</p>	<p>1 12</p>
	<p>CLASSIC ELEGANCE <i>BATH AND SHOWER SET</i></p> <ul style="list-style-type: none"> • compression • three metal handles • heavy duty three valve chrome plated combination • Gerber compatible parts 	<p>TNS - 500 - AS SHOWN</p>	<p>1 6</p>
	<p>CLASSIC ELEGANCE <i>BATH AND SHOWER SET</i></p> <ul style="list-style-type: none"> • compression • chrome plated die cast diverter • two metal handles • chrome plated brass shower head, arm & flange • IPS connection 	<p>TNS - 782 - AS SHOWN</p>	<p>1 12</p>
	<p>CLASSIC ELEGANCE <i>SHOWER ONLY</i></p> <ul style="list-style-type: none"> • compression • chrome plated die cast diverter • two metal handles 	<p>TNS - 782S - AS SHOWN</p>	<p>1 6</p>
	<p>CLASSIC ELEGANCE <i>BATH FILLER AND HANDLE SET</i></p> <ul style="list-style-type: none"> • compression • chrome plated die cast diverter • two metal handles 	<p>TNS - 782T - AS SHOWN</p>	<p>1 6</p>
	<p>CLASSIC ELEGANCE <i>BATH AND SHOWER SET</i></p> <ul style="list-style-type: none"> • compression • chrome plated die cast diverter • three chrome plated metal handles • chrome plated brass shower head, arm & flange • IPS connection 	<p>TNS - 783 - AS SHOWN</p>	<p>1 12</p>

IMAGE * JOB PACKS SECTION * MODEL NO. / FINISH MASTER



CLASSIC ELEGANCE
KITCHEN FAUCET JOB PACK

- washerless cartridge
- 8" centers
- single lever metal handle
- with spray



JOB PACKS SAVE TIME AND MONEY!
CONVENIENTLY PACKAGED IN PLASTIC BAGS -
THERE ARE NO DISPLAY BOXES TO THROW AWAY!

FT - 210JP - AS SHOWN **12**



CLASSIC ELEGANCE
KITCHEN FAUCET JOB PACK

- washerless cartridge
- 8" centers
- two acrylic handles
- with spray



JOB PACKS SAVE TIME AND MONEY!
CONVENIENTLY PACKAGED IN PLASTIC BAGS -
THERE ARE NO DISPLAY BOXES TO THROW AWAY!

FT - 310JP - AS SHOWN **12**



CLASSIC ELEGANCE EURO
KITCHEN FAUCET JOB PACK

- washerless cartridge
- 8" centers
- two acrylic handles
- with spray



JOB PACKS SAVE TIME AND MONEY!
CONVENIENTLY PACKAGED IN PLASTIC BAGS -
THERE ARE NO DISPLAY BOXES TO THROW AWAY!

FT - 310EDJP - AS SHOWN **12**



CLASSIC ELEGANCE EURO
KITCHEN FAUCET JOB PACK

- washerless cartridge
- 8" centers
- solid single lever handle
- with spray



JOB PACKS SAVE TIME AND MONEY!
CONVENIENTLY PACKAGED IN PLASTIC BAGS -
THERE ARE NO DISPLAY BOXES TO THROW AWAY!

FT - 210SELJP - AS SHOWN **12**
FT - 210SELSJP - BRUSHED NICKEL



IMAGE * JOB PACKS SECTION * MODEL NO. / FINISH MASTER



JOB PACKS SECTION

CLASSIC ELEGANCE
LAVATORY FAUCET JOB PACK

- washerless cartridge
- 4" centerset
- single acrylic handle
- with brass pop-up



JOB PACKS SAVE TIME AND MONEY!
CONVENIENTLY PACKAGED IN PLASTIC BAGS -
THERE ARE NO DISPLAY BOXES TO THROW AWAY!

CT - 452JP - AS SHOWN **12**



JOB PACKS SECTION

CLASSIC ELEGANCE
LAVATORY FAUCET JOB PACK

- 4" centerset
- single metal lever handle
- with brass pop-up



JOB PACKS SAVE TIME AND MONEY!
CONVENIENTLY PACKAGED IN PLASTIC BAGS -
THERE ARE NO DISPLAY BOXES TO THROW AWAY!

CT - 452DJP - AS SHOWN **12**



JOB PACKS SECTION

CLASSIC ELEGANCE
LAVATORY FAUCET JOB PACK

- washerless cartridge
- 4" centerset
- two acrylic handles
- with brass pop-up



JOB PACKS SAVE TIME AND MONEY!
CONVENIENTLY PACKAGED IN PLASTIC BAGS -
THERE ARE NO DISPLAY BOXES TO THROW AWAY!

CT - 852JP - AS SHOWN **12**

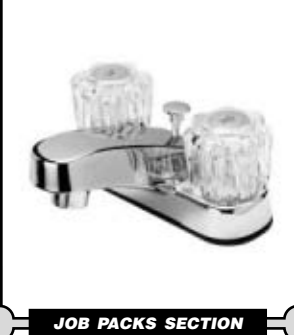

JOB PACKS SECTION

CLASSIC ELEGANCE EURO
LAVATORY FAUCET JOB PACK

- washerless cartridge
- 4" centerset
- two acrylic handles
- with brass pop-up



JOB PACKS SAVE TIME AND MONEY!
CONVENIENTLY PACKAGED IN PLASTIC BAGS -
THERE ARE NO DISPLAY BOXES TO THROW AWAY!

CT - 852EDJP - AS SHOWN **12**



JOB PACKS SECTION

CLASSIC ELEGANCE EURO
LAVATORY FAUCET JOB PACK

- washerless cartridge
- 4" centerset
- solid single lever
- with brass pop-up



JOB PACKS SAVE TIME AND MONEY!
CONVENIENTLY PACKAGED IN PLASTIC BAGS -
THERE ARE NO DISPLAY BOXES TO THROW AWAY!

CT - 452SELJP - AS SHOWN **12**
CT - 452SELSJP - BRUSHED NICKEL **12**



IMAGE	* JOB PACKS SECTION *	MODEL NO. / FINISH	MASTER
	CLASSIC ELEGANCE EURO <i>BODY ONLY</i>	TNS - 100PB-BW - AS SHOWN	12
		TNS - 100PB-BWC - SWEAT CONNECTION	12
	<ul style="list-style-type: none"> • washerless cartridge • pressure balancing valve • integral stops 	TNS - 100PB-BWPX - PEX CONNECTION	12
	CLASSIC ELEGANCE EURO <i>BODY ONLY</i>	TNS - 100PB-B - AS SHOWN	12
		TNS - 100PB-BC - SWEAT CONNECTION	12
	<ul style="list-style-type: none"> • ceramic cartridge • pressure balancing valve • integral stops 		
	CLASSIC ELEGANCE EURO <i>BATH AND SHOWER TRIM ONLY KIT</i>	TNS - 100PB-TWSL - AS SHOWN	12
		TNS - 100PB-TWLSLR - BRUSHED NICKEL HUB & CAP	12
	<ul style="list-style-type: none"> • chrome plated • solid lever handle • brass shower arm • massage shower head • less spout 		
	CLASSIC ELEGANCE EURO <i>TRIM ONLY</i>	TNS - 101PB-TWSL AS SHOWN	12
		TNS - 101PB-TWLSLR - TRIM KIT, LESS BATH SPOUT, LESS SHOWERHEAD	12
	CLASSIC ELEGANCE EURO <i>HAND SHOWER</i>	M - 350 - AS SHOWN	3
		M - 350S - BRUSHED NICKEL	3
	<ul style="list-style-type: none"> • CP massage shower head • solid brass ball joint • regular spray, fine spray, massage & spray, full flow • 1/2" FIP 		
	CLASSIC ELEGANCE EURO <i>BALL JOINT SHOWER HEAD</i>	S - 125 - AS SHOWN	3
		S - 125WS - WATER SAVER SHOWERHEAD	3
	<ul style="list-style-type: none"> • chrome plate ABS • ball joint • 1/2" FIP • S-125WS = 1.5 GPM watersaver with pressure compensated flow restrictor 		
	CLASSIC ELEGANCE EURO <i>BATH SPOUT</i>	FY - 801 - AS SHOWN	48
	<ul style="list-style-type: none"> • chrome plated brass • diverter spout • 3/4" FIP inlet in tail 		
	CLASSIC ELEGANCE EURO <i>BATH SPOUT</i>	FY - 804DC - AS SHOWN	50
		FY - 804DCS - BRUSHED NICKEL	50
	<ul style="list-style-type: none"> • chrome plated die cast • diverter spout • slip on for 1/2" copper tubing 		

* FOR A COMPLETE LINE OF SHOWERHEADS SEE PAGES 33-35

* FOR A COMPLETE LINE OF SHOWERHEADS SEE PAGES 33-35

* FOR A COMPLETE LINE OF BATH SPOUTS SEE PAGES 37

* FOR A COMPLETE LINE OF BATH SPOUTS SEE PAGES 37



IMAGE	DESCRIPTION	MODEL NO. / FINISH	INNER	MASTER
	<p>POSITANO COLLECTION <i>KITCHEN FAUCET</i></p> <ul style="list-style-type: none"> ceramic cartridge 8" centers two lever handles goose neck spout 	AE - 915 - WITH SPRAY - CHROME PLATED	1	6
		AE - 905 - W/O SPRAY - CHROME PLATED	1	6
		AE - 915S - WITH SPRAY - BRUSHED NICKEL	1	6
		AE - 905S - W/O SPRAY - BRUSHED NICKEL	1	6
		AE - 915B - WITH SPRAY - PVD BRASS	1	6
		AE - 905B - W/O SPRAY - PVD BRASS	1	6
		AE - 915KIT - CONVERTS TO PVD BRASS	1	6
	TWO-TONE HANDLES, INSERTS, AERATOR, BASE RINGS			
	<p>POSITANO COLLECTION <i>LAVATORY FAUCET</i></p> <ul style="list-style-type: none"> ceramic cartridge 4" centers lever handles brass pop-up 	AE - 805 - AS SHOWN	1	6
		AE - 855 - WITH POP-UP	1	6
		AE - 855S - BRUSHED NICKEL	1	6
		AE - 805S - BRUSHED NICKEL LESS POP-UP	1	6
		AE - 855B - PVD BRASS	1	6
		AE - 855KIT - CONVERTS TO PVD BRASS	1	6
			TWO-TONE HANDLES, INSERTS, AERATOR, BASE RINGS	
	<p>POSITANO COLLECTION <i>LAVATORY WIDESPREAD FAUCET</i></p> <ul style="list-style-type: none"> ceramic cartridge 4"-16" spread two lever handles mini - widespread 5 - 1/2" spout with brass pop-up 	AE - 150 - AS SHOWN	1	6
		AE - 150S - BRUSHED NICKEL	1	6
		AE - 150B - PVD BRASS	1	6
		AE - 150KIT - CONVERTS TO PVD BRASS	1	6
			TWO-TONE HANDLES, INSERTS, AERATOR, BASE RINGS	
	<p>POSITANO COLLECTION <i>ROMAN BATH FILLER</i></p> <ul style="list-style-type: none"> ceramic cartridge chrome plated deck mount two lever handles 7-1/2" spout 	AE - 151 - AS SHOWN	1	6
		AE - 151S - BRUSHED NICKEL	1	6
		AE - 151B - PVD BRASS	1	6
		AE - 151KIT - CONVERTS TO PVD BRASS	1	6
			TWO-TONE HANDLES, INSERTS, AERATOR, BASE RINGS	
	<p>POSITANO COLLECTION <i>SHOWER ONLY</i></p> <ul style="list-style-type: none"> washerless cartridge chrome plated single lever handle pressure balanced integral stops 	AE - 100SPBW AS SHOWN	1	8
		AE - 100SPBWS - BRUSHED NICKEL	1	8
		AE - 100SPBWB - PVD BRASS	1	8
		AE - 100PBWKIT - CONVERTS TO	1	8
			TWO-TONE BRASS LEVER, SHOWER ESCUTCHEN AND BRASS TRIMMED SHOWERHEAD	
	<p>POSITANO COLLECTION <i>BATH AND SHOWER FAUCET</i></p> <ul style="list-style-type: none"> washerless cartridge chrome plated single lever pressure balanced integral stops 	AE - 100PBW - AS SHOWN	1	8
		AE - 100PBWS - BRUSHED NICKEL	1	8
		AE - 100PBWB - PVD BRASS	1	8
		AE - 100PBWKIT - CONVERTS TO	1	24
			TWO-TONE BRASS LEVER, SHOWER ESCUTCHEN AND BRASS TRIMMED SHOWERHEAD	



























IMAGE	DESCRIPTION	MODEL NO. / FINISH	INNER	MASTER	
	RAVELLO KITCHEN FAUCET <ul style="list-style-type: none"> ceramic cartridge 8" centers single lever with spray 	 	AE - 315 - AS SHOWN	1	6
			AE - 310 - LESS SPRAY	1	6
			AE - 315S - BRUSHED NICKEL	1	6
			AE - 310S - LESS SPRAY	1	6
BRUSHED NICKEL					
	RAVELLO KITCHEN FAUCET <ul style="list-style-type: none"> washerless cartridge 8" centers two lever handles with spray 	 	AE - 366 - AS SHOWN	1	6
			AE - 365 - LESS SPRAY	1	6
			AE - 366S - BRUSHED NICKEL	1	6
			AE - 365S - LESS SPRAY	1	6
BRUSHED NICKEL					
	RAVELLO BAR FAUCET <ul style="list-style-type: none"> washerless cartridge 4" centers two metal lever handles 10" spout 	 	AE - 930 - AS SHOWN	1	6
			AE - 930S - BRUSHED NICKEL	1	6
	RAVELLO LAVATORY FAUCET <ul style="list-style-type: none"> ceramic cartridge 4" centers single lever with brass pop-up 	 	AE - 495 - AS SHOWN	1	6
			AE - 490 - LESS POP-UP	1	6
			AE - 495S - BRUSHED NICKEL	1	6
			AE - 490S - LESS POP-UP	1	6
BRUSHED NICKEL					
	RAVELLO LAVATORY FAUCET <ul style="list-style-type: none"> washerless cartridge 4" centers two lever handles with brass pop-up 	 	AE - 885 - AS SHOWN	1	6
			AE - 880 - LESS POP-UP	1	6
			AE - 885S - BRUSHED NICKEL	1	6
			AE - 880S - LESS POP-UP	1	6
BRUSHED NICKEL					
	RAVELLO LAVATORY WIDESPREAD <ul style="list-style-type: none"> washerless cartridge 4" 16" spread two lever handles with brass pop-up 	 	AE - 185 - AS SHOWN	1	6
			AE - 185S - BRUSHED NICKEL	1	6
	RAVELLO ROMAN BATH FILLER <ul style="list-style-type: none"> ceramic cartridge two lever handles with side spray deck mount, rough in body chrome plated slip fit trim 	 	AE - 187 - AS SHOWN	1	6
			AE - 186 - LESS SIDE SPRAY	1	6
			AE - 187S - BRUSHED NICKEL	1	6
			AE - 186S - LESS SIDE SPRAY	1	6
BRUSHED NICKEL					
	RAVELLO BIDET <ul style="list-style-type: none"> ceramic cartridge chrome plated two lever handles handles available to match Portia & Napoli collections 	 	AE - 440 - AS SHOWN	1	6
			AE - 440S - BRUSHED NICKEL	1	6
	RAVELLO BATH AND SHOWER SET <ul style="list-style-type: none"> washerless cartridge solid lever handle pressure balancing valve massage shower head diverter spout - IPS connection 	 	TNS - 100PBWSL AS SHOWN	1	8
			TNS - 100PBWSLS BRUSHED NICKEL	1	8
			TNS - 100PBWCSL SWEAT CONNECT	1	8







IMAGE	DESCRIPTION	MODEL NO. / FINISH	INNER MASTER		
	<p>NAPOLI <i>KITCHEN FAUCET</i></p> <ul style="list-style-type: none"> ceramic cartridge 8" centers two lever handles with spray 	<p>NEW</p>	AE - 965 - AS SHOWN	1	6
			AE - 960 - LESS SPRAY	1	6
			AE - 965S - BRUSHED NICKEL	1	6
			AE - 960S - LESS SPRAY	1	6
			BRUSHED NICKEL		
	<p>NAPOLI <i>BAR FAUCET</i></p> <ul style="list-style-type: none"> washerless cartridge 4" centers two lever handles 10" spout 	<p>NEW</p>	AE - 360 - AS SHOWN	1	6
			AE - 360S - BRUSHED NICKEL	1	6
	<p>NAPOLI <i>LAVATORY FAUCET</i></p> <ul style="list-style-type: none"> ceramic cartridge 4" centers two lever handles with brass pop-up 	<p>NEW</p>	AE - 835 - AS SHOWN	1	6
			AE - 835S - BRUSHED NICKEL	1	6
	<p>NAPOLI <i>WIDESPREAD LAVATORY FAUCET</i></p> <ul style="list-style-type: none"> ceramic cartridge 4"-16" spread two lever handles three hole mount with brass pop-up 	<p>NEW</p>	AE - 135 - AS SHOWN	1	6
			AE - 135S - BRUSHED NICKEL	1	6
	<p>NAPOLI <i>ROMAN BATH FILLER</i></p> <ul style="list-style-type: none"> ceramic cartridge two lever handles rough in body slip fit trim 	<p>NEW</p>	AE - 136 - AS SHOWN	1	6
			AE - 136S - BRUSHED NICKEL	1	6
	<p>POSITANO <i>BATH AND SHOWER FAUCET</i></p> <ul style="list-style-type: none"> washerless cartridge chrome plated single lever pressure balanced bath & shower trim kit includes: lever handle, faceplate & screws in PVD brass diverter spout - IPS connection 	<p>NEW</p>	AE - 100PBW - AS SHOWN	1	8
			AE - 100PBWS - BRUSHED NICKEL	1	8
			AE - 100SPBW - SHOWER ONLY	1	8
			AE - 100SPBWS - SHOWER ONLY	1	8







IMAGE	DESCRIPTION	MODEL NO. / FINISH	INNER	MASTER
	<p>PORTIA <i>PULL-OUT SPOUT KITCHEN FAUCET</i></p> <ul style="list-style-type: none"> • ceramic cartridge • chrome plated • for one or three hole applications • pull-out spout • optional deck plate included 	AE - 255 - AS SHOWN	1	6
		AE - 255S - BRUSHED NICKEL	1	6
	<p>PORTIA <i>KITCHEN FAUCET</i></p> <ul style="list-style-type: none"> • ceramic cartridge • chrome plated • single lever handle • goose neck spout • with spray 	AE - 955 - AS SHOWN	1	6
		AE - 955S - BRUSHED NICKEL	1	6
		AE - 955ORB - OIL RUBBED BRONZE	1	6
	<p>PORTIA <i>KITCHEN FAUCET</i></p> <ul style="list-style-type: none"> • washerless cartridge • 8" centers • two lever handle • goose neck spout, with spray • two-tone kit includes: handle inserts, aerator, handle & spout base rings in pvd brass 	AE - 925 - AS SHOWN	1	6
		AE - 925S - BRUSHED NICKEL	1	6
		AE - 925ORB - OIL RUBBED BRONZE	1	6
		AE - 925KIT - TWO-TONE KIT IN PVD BRASS	1	6
	<p>PORTIA <i>BAR FAUCET</i></p> <ul style="list-style-type: none"> • ceramic cartridge • chrome plated • single lever handle • 10" high arc spout 	AE - 956 - AS SHOWN	1	6
		AE - 956S - BRUSHED NICKEL	1	6
		AE - 956ORB - OIL RUBBED BRONZE	1	6
	<p>PORTIA <i>BAR FAUCET</i></p> <ul style="list-style-type: none"> • washerless cartridge • 4" centers • two lever handle • 10" arc spout 	AE - 325 - AS SHOWN	1	6
		AE - 325S - BRUSHED NICKEL	1	6
	<p>PORTIA <i>LAVATORY FAUCET</i></p> <ul style="list-style-type: none"> • washerless cartridge • 4" centers • two lever handle • with brass pop-up • two-tone kit includes: lever handles, aerator, pop-up knob in pvd brass 	AE - 865 - AS SHOWN	1	6
		AE - 865S - BRUSHED NICKEL	1	6
		AE - 865ORB - OIL RUBBED BRONZE	1	6
		AE - 865KIT - TWO-TONE KIT IN PVD BRASS	1	6

IMAGE	DESCRIPTION	MODEL NO. / FINISH	INNER	MASTER	
	<p>PORTIA <i>WIDESPREAD LAVATORY FAUCET</i></p> <ul style="list-style-type: none"> washerless cartridge 4"-16" spread two lever handles three hole mount brass pop-up 	AE - 165 - AS SHOWN	1	6	
		AE - 165S - BRUSHED NICKEL	1	6	
		AE - 165ORB - OIL RUBBED BRONZE	1	6	
		AE - 165KIT - TWO-TONE KIT INCLUDES HANDLE LEVERS, AERATOR, POP-UP IN PVD BRASS	1	6	
	<p>PORTIA <i>ROMAN BATH FILLER</i></p> <ul style="list-style-type: none"> ceramic cartridge chrome plated two lever handles rough in body slip fit trim 	AE - 155 - AS SHOWN	1	6	
		AE - 155S - BRUSHED NICKEL	1	6	
		AE - 155ORB - OIL RUBBED BRONZE	1	6	
		AE - 155KIT - TWO-TONE KIT INCLUDES HANDLE LEVERS, AERATOR, POP-UP IN PVD BRASS	1	24	
	<p>PORTIA <i>BATH AND SHOWER FAUCET SET</i></p> <ul style="list-style-type: none"> diverter spout - IPS com washerless cartridge chrome plated single lever handle pressure balanced 	AE - 105PBW AS SHOWN	1	6	
		AE - 105PBWS - BRUSHED NICKEL	1	6	
		AE - 105PBWORB - OIL RUBBED BRONZE	1	6	
		AE - 105SPBW - CHROME	1	6	
		AE - 105SPBWS - BRUSHED NICKEL	1	6	
		AE - 105SPBWORB - OIL RUBBED BRONZE	1	6	
AE - 105PBWKIT - TRIM KIT PVD BRASS	1	24			
	<p>PORTIA <i>ROBE HOOK</i></p> <ul style="list-style-type: none"> chrome plated robe hook available in chrome, brushed nickel finish and oil rubbed bronze finish 	AC - RHCPPOR - CHROME	1	6	
		AC - RHBNPOR - BRUSHED NICKEL	1	6	
		AC - RHORBPOR - OIL RUBBED BRONZE	1	6	
	<p>PORTIA <i>TOWEL RING</i></p> <ul style="list-style-type: none"> 7" chrome plated towel ring available in chrome, brushed nickel finish and oil rubbed bronze finish 	AC - TRCPPOR - CHROME	1	6	
		AC - TRBNPOR - BRUSHED NICKEL	1	6	
		AC - TRORBPOR - OIL RUBBED BRONZE	1	6	
	<p>PORTIA <i>TOWEL BAR</i></p> <ul style="list-style-type: none"> 24" chrome plated towel bar with brackets available in chrome, brushed nickel finish and oil rubbed bronze finish 	AC - TB24CPPOR - CHROME	1	6	
		AC - TB24BNPOR - BRUSHED NICKEL	1	6	
		AC - TB24ORBPOR - OIL RUBBED BRONZE	1	6	
	<p>PORTIA <i>PAPER HOLDER</i></p> <ul style="list-style-type: none"> chrome plated toilet paper holder available in chrome, brushed nickel finish and oil rubbed bronze finish 	AC - PHCPPOR - CHROME	1	6	
		AC - PHBNPOR - BRUSHED NICKEL	1	6	
		AC - PHORBPOR - OIL RUBBED BRONZE	1	6	

IMAGE	DESCRIPTION	MODEL NO. / FINISH	INNER	MASTER	
	<p>CRESCENDO <i>WIDESPREAD KITCHEN FAUCET</i></p> <ul style="list-style-type: none"> ceramic cartridge two lever handles less deck plate with spray available in chrome, brushed nickel, and oil rubbed bronze 	<p>AE - 945 - AS SHOWN</p> <p>AE - 945S - BRUSHED NICKEL</p> <p>AE - 945AB - ANTIQUE COPPER</p> <p>AE - 945ORB - OIL RUBBED BRONZE</p>	<p>1</p> <p>1</p> <p>1</p> <p>1</p>	<p>6</p> <p>6</p> <p>6</p> <p>6</p>	
		<p>CRESCENDO <i>KITCHEN FAUCET</i></p> <ul style="list-style-type: none"> ceramic cartridge 8" centers two lever handles with spray available in chrome, brushed nickel, and oil rubbed bronze 	<p>AE - 935 - AS SHOWN</p> <p>AE - 935S - BRUSHED NICKEL</p> <p>AE - 935ORB - OIL RUBBED BRONZE</p>	<p>1</p> <p>1</p> <p>1</p>	<p>6</p> <p>6</p> <p>6</p>
			<p>CRESCENDO <i>LAVATORY FAUCET</i></p> <ul style="list-style-type: none"> ceramic cartridge 4" centers two lever handles with brass pop-up available in chrome, brushed nickel, and oil rubbed bronze 	<p>AE - 875 - AS SHOWN</p> <p>AE - 875S - BRUSHED NICKEL</p> <p>AE - 875ORB - OIL RUBBED BRONZE</p>	<p>1</p> <p>1</p> <p>1</p>
			<p>CRESCENDO <i>WIDESPREAD LAVATORY FAUCET</i></p> <ul style="list-style-type: none"> ceramic cartridge 4" -16" spread two lever handles 3 hole mount brass pop-up available in chrome, brushed nickel, and oil rubbed bronze 	<p>AE - 175 - AS SHOWN</p> <p>AE - 175S - BRUSHED NICKEL</p> <p>AE - 175AB - ANTIQUE COPPER</p> <p>AE - 175ORB - OIL RUBBED BRONZE</p>	<p>1</p> <p>1</p> <p>1</p> <p>1</p>
			<p>CRESCENDO <i>ROMAN BATH FILLER</i></p> <ul style="list-style-type: none"> ceramic cartridge two lever handles available in chrome, brushed nickel, and oil rubbed bronze 	<p>AE - 176 - AS SHOWN</p> <p>AE - 176S - BRUSHED NICKEL</p> <p>AE - 176AB - ANTIQUE COPPER</p> <p>AE - 176ORB - OIL RUBBED BRONZE</p>	<p>1</p> <p>1</p> <p>1</p> <p>1</p>

IMAGE	DESCRIPTION	MODEL NO. / FINISH	INNER	MASTER
	<p>CRESCENDO <i>BATH AND SHOWER FAUCET SET</i></p> <ul style="list-style-type: none"> washerless cartridge single lever handle pressure balanced integral stops diverter spout - IPS connection 	AE - 110PBW - AS SHOWN	1	8
		AE - 110PBWS - BRUSHED NICKEL	1	8
		AE - 110PBWAB - ANTIQUE COPPER	1	8
		AE - 110PBWORB - OIL RUBBED BRONZE	1	8
		→ SHOWER ONLY		
		AE - 110SPBW - CHROME	1	6
		AE - 110SPBWS - BRUSHED NICKEL	1	6
AE - 110SPWAB - ANTIQUE COPPER	1	6		
AE - 110SPWORB - OIL RUBBED BRONZE	1	6		
	<p>CRESCENDO <i>ROBE HOOK</i></p> <ul style="list-style-type: none"> chrome plated robe hook available in chrome, brushed nickel and oil rubbed bronze finish 	AC - RHPCRES - CHROME	1	6
		AC - RHBCRES - BRUSHED NICKEL	1	6
		AC - RHOBRCRES - OIL RUBBED BRONZE	1	6
	<p>CRESCENDO <i>TOWEL RING</i></p> <ul style="list-style-type: none"> 7" chrome plated towel ring available in chrome, brushed nickel and oil rubbed bronze finish 	AC - TRPCRES - CHROME	1	6
		AC - TRBCRES - BRUSHED NICKEL	1	6
		AC - TRORBCRES - OIL RUBBED BRONZE	1	6
	<p>CRESCENDO <i>TOWEL BAR</i></p> <ul style="list-style-type: none"> 24" chrome plated towel bar with brackets available in chrome, brushed nickel and oil rubbed bronze finish 	AC - TB24PCRES - CHROME	1	6
		AC - TB24BCRES - BRUSHED NICKEL	1	6
		AC - TB24ORBCRES - OIL RUBBED BRONZE	1	6
	<p>CRESCENDO <i>PAPER HOLDER</i></p> <ul style="list-style-type: none"> chrome plated toilet paper holder available in chrome, brushed nickel and oil rubbed bronze finish 	AC - PHPCRES - CHROME	1	6
		AC - PHBCRES - BRUSHED NICKEL	1	6
		AC - PHORBCRES - OIL RUBBED BRONZE	1	6

IMAGE	DESCRIPTION	MODEL NO. / FINISH	INNER MASTER		
	<p>PADOVA <i>KITCHEN FAUCET</i></p> <ul style="list-style-type: none"> • 8" centers • ceramic cartridge • chrome plated • single lever handle • with spray • available with deck rings & deck plate 	<p>NEW</p>	AE - 295 - AS SHOWN	1	6
			AE - 295S - BRUSHED NICKEL	1	6
	<p>PADOVA <i>WIDESPREAD KITCHEN FAUCET</i></p> <ul style="list-style-type: none"> • ceramic cartridge • chrome plated • four hole mount • two lever handles • with spray 	<p>NEW</p>	AE - 195 - AS SHOWN	1	6
			AE - 195S - BRUSHED NICKEL	1	6
	<p>PADOVA <i>LAVATORY FAUCET</i></p> <ul style="list-style-type: none"> • 4" centers • ceramic cartridge • chrome plated • single hole mount • two lever handles • with brass pop-up • available with deck rings & deck plate 	<p>NEW</p>	AE - 895 - AS SHOWN	1	6
			AE - 895S - BRUSHED NICKEL	1	6
	<p>PADOVA <i>WIDESPREAD LAVATORY FAUCET</i></p> <ul style="list-style-type: none"> • ceramic cartridge • chrome plated widespread • three hole mount • two lever handles • with brass pop-up 	<p>NEW</p>	AE - 995 - AS SHOWN	1	6
			AE - 995S - BRUSHED NICKEL	1	6
	<p>PADOVA <i>VESSEL FILLER</i></p> <ul style="list-style-type: none"> • ceramic cartridge • chrome plated • single hole mount • with brass pop-up 	<p>NEW</p>	AE - 975 - AS SHOWN	1	6
			AE - 970 - LESS POP-UP	1	6
			AE - 975S - BRUSHED NICKEL	1	6
			AE - 970S - LESS POP-UP	1	6
	<p>PADOVA <i>ROMAN BATH FILLER</i></p> <ul style="list-style-type: none"> • ceramic cartridge • chrome plated • three hole mount • two lever handles 	<p>NEW</p>	AE - 985 - AS SHOWN	1	6
			AE - 985S - BRUSHED NICKEL	1	6

IMAGE	DESCRIPTION	MODEL NO. / FINISH	INNER	MASTER		
	<p>PADOVA <i>ROMAN BATH FILLER</i></p> <ul style="list-style-type: none"> ceramic cartridge chrome plated five hole mount two lever handles with side spray 	<p>NEW</p> <p></p>	AE - 986 - AS SHOWN	1	6	
			AE - 986S - BRUSHED NICKEL	1	6	
	<p>PADOVA <i>BATH AND SHOWER SET</i></p> <ul style="list-style-type: none"> washerless cartridge chrome plated single lever handle pressure balanced bath spout IPS connection 	<p>NEW</p> <p></p>	AE - 115PBW - AS SHOWN	1	6	
			AE - 115PBWS - BRUSHED NICKEL	1	6	
			<i>SHOWER ONLY</i>			
			AE - 115SPBW - CHROME	1	6	
			AE - 115SPBWS - BRUSHED NICKEL	1	6	
	<p>PADOVA <i>ROBE HOOK</i></p> <ul style="list-style-type: none"> chrome plated robe hook available in chrome, brushed nickel 	<p>NEW</p>	AC - RHCPPAD - CHROME	1	6	
			AC - RHBNPAD - BRUSHED NICKEL	1	6	
	<p>PADOVA <i>TOWEL RING</i></p> <ul style="list-style-type: none"> 7" chrome plated towel ring available in chrome, brushed nickel 	<p>NEW</p>	AC - TRCPPAD - CHROME	1	6	
			AC - TRBNPAD - BRUSHED NICKEL	1	6	
	<p>PADOVA <i>TOWEL BAR</i></p> <ul style="list-style-type: none"> 24" chrome plated towel bar with brackets available in chrome, brushed nickel 	<p>NEW</p>	AC - TB 24CPPAD - CHROME	1	6	
			AC - TB 24BNPAD - BRUSHED NICKEL	1	6	
	<p>PADOVA <i>PAPER HOLDER</i></p> <ul style="list-style-type: none"> chrome plated toilet paper holder available in chrome, brushed nickel 	<p>NEW</p>	AC - PHCPPAD - CHROME	1	6	
			AC - PHBNPAD - BRUSHED NICKEL	1	6	









IMAGE	DESCRIPTION	MODEL NO. / FINISH	INNER	MASTER
	<p>NON- METALIC <i>LAVATORY FAUCET</i></p> <ul style="list-style-type: none"> • 4" centers • two acrylic handles • with pop-up • <i>available in blister packs!</i> 	<p>BLISTER PACKS</p> <p>NM - 850 - AS SHOWN</p> <p>NM - 800 - LESS POP-UP</p>	1	12
			1	12
	<p>NON- METALIC <i>KITCHEN FAUCET</i></p> <ul style="list-style-type: none"> • 8" centers • two acrylic handles • with spray • <i>available in blister packs!</i> 	<p>BLISTER PACKS</p> <p>NM - 300 - AS SHOWN - LESS SPRAY</p> <p>NM - 310 - WITH SPRAY</p>	1	12
			1	12
	<p>NON- METALIC <i>BATH AND SHOWER SET</i></p> <ul style="list-style-type: none"> • chrome plated plastic • two acrylic handles, arm, flange • with diverter spout 	<p>NM - 600 - AS SHOWN</p> <p>NM - 620 - SHOWER HEAD WITH ACRYLIC HANDLES, ARM AND FLANGE</p>	1	12
			1	12
	<p>NON- METALIC <i>LAUNDRY FAUCET</i></p> <ul style="list-style-type: none"> • 4" centers • two acrylic handles 	NM - 985 - AS SHOWN	1	12
	<p>NON- METALIC <i>BAR FAUCET</i></p> <ul style="list-style-type: none"> • 4" centers • two acrylic handles 	NM - 990 - AS SHOWN	1	12
	<p>NON- METALIC <i>MIXING VALVE</i></p> <ul style="list-style-type: none"> • 4" centers • mixing valve with vacuum breaker • acrylic handles • IAPMO approved 	NM - 400C - AS SHOWN	1	12
	<p>NON- METALIC <i>ROMAN BATH FILLER</i></p> <ul style="list-style-type: none"> • chrome plated plastic • three piece 	NM - 151C - AS SHOWN	1	12
	<p>NON- METALIC <i>ROMAN BATH FILLER</i></p> <ul style="list-style-type: none"> • chrome plated plastic • one piece 	NM - 152C - AS SHOWN	1	12
	<p>NON- METALIC <i>SHOWER KIT</i></p> <ul style="list-style-type: none"> • chrome plated plastic shower head, arm and flange kit 	S - 6134CMH - AS SHOWN	1	12
		S - 6134WMH - KIT - ALL WHITE	1	12
		S - 6134CBMH - KIT - ALL CHROME	1	12









IMAGE	DESCRIPTION	MODEL NO. / FINISH	INNER	MASTER
	KITCHEN FAUCET <i>WALL MOUNT</i>	FT - 306 - AS SHOWN	1	24
	<ul style="list-style-type: none"> • 8" centers chrome plated • wall mount • two metal lever handles • 6" cast spout • with soap dish 	FT - 308 - WITH 8" CAST SPOUT	1	24
		FT - 312 - WITH 12" TUBULAR SPOUT	1	24
	KITCHEN FAUCET <i>WALL MOUNT</i>	FT - 375 - AS SHOWN	1	24
	<ul style="list-style-type: none"> • 8" centers chrome plated • wall mount • two metal lever handles • less soap dish • 6" cast spout adustable from 7" - 9" 	FT - 375SD - WITH SOAP DISH	1	24
	SERVICE SINK FAUCET <i>WALL BRACKET</i>	FT - 350 - AS SHOWN	1	8
	<ul style="list-style-type: none"> • heavy duty cast brass • vacuum breaker & bucket hook • with integral stops • chrome plated satin finish 			
	LAUNDRY FAUCET	FY - 980 - AS SHOWN	1	24
	<ul style="list-style-type: none"> • rough brass laundry tray • two lever handles 			
	LAUNDRY FAUCET	FY - 985 - AS SHOWN	1	24
	<ul style="list-style-type: none"> • 4" centers chrome plated • laundry tray • two metal handles • 6" spout • aerator & hose adapter 	FY - 986 - WITH 8" SPOUT	1	24
		FY - 987 - WITH 12" SPOUT	1	24
	LAUNDRY FAUCET	FY - 999WB - AS SHOWN	1	12
	<ul style="list-style-type: none"> • washerless cartridge • 4" centers chrome plated • two wrist blade handles • 6" spout 			
	BAR FAUCET <i>DECK MOUNT</i>	RQ - 400 - AS SHOWN	1	24
	<ul style="list-style-type: none"> • heavy duty • 4" centers chrome plated • deck mount • two metal lever handles • goose spout (bar faucet) 			
	LAUNDRY FAUCET <i>DECK MOUNT</i>	RQ - 406 - AS SHOWN	1	24
	<ul style="list-style-type: none"> • heavy duty • 4" centers chrome plated • deck mount • two metal round handles • 6" swing spout 	RQ - 412 - 12" SWING SPOUT	1	12
	WALL FAUCET <i>WALL MOUNT</i>	RQ - 808 - AS SHOWN	1	24
	<ul style="list-style-type: none"> • heavy duty • 8" centers chrome plated • wall mount • two metal lever handles • 8" cast brass spout 	RQ - 812 - 12" SPOUT	1	24
		RQ - 816 - 16" SPOUT	1	12

IMAGE	DESCRIPTION	MODEL NO. / FINISH	INNER	MASTER
	<p>AERATOR</p> <ul style="list-style-type: none"> • 15/16" 2 G.P.M. • fits male and female 	AIR - 1516 - AS SHOWN	100	1000
		AIR - 5564 - 55/64" 2 G.P.M	100	1000
		FEMALE AERATOR		
	<p>AERATOR</p> <ul style="list-style-type: none"> • chrome plated low-flow aerator • 1.5 GPM @ 60 PSI • fits all FT & CT series of faucets 	AER - 15 - AS SHOWN	100	1000
	<p>HOSE & SPRAY <i>KITCHEN FAUCET</i></p> <ul style="list-style-type: none"> • 4' replacement hose • with universal coupling • with black spray head 	HS - 300 - AS SHOWN	1	50
		HS - 300W - WITH WHITE SPRAY HEAD	1	100
		HS - 200 - WITH HOSE COUPLING ONLY	1	100
		HS - 100 - HEAD ONLY	1	100
	<p>DRINKING FOUNTAIN</p> <ul style="list-style-type: none"> • drinking fountain 	FY - 930 - AS SHOWN	1	8
	<p>FAUCET HOLE COVER</p> <ul style="list-style-type: none"> • size: 1-7/8" 	CH - 175 - AS SHOWN	1	500
	<p>PLUMBER'S TOOL</p> <ul style="list-style-type: none"> • 5 piece plumber's socket wrench set 	SW - 100 - AS SHOWN	1	20
	<p>INTEGRAL STOP <i>FOR SHOWER VALVES</i></p> <ul style="list-style-type: none"> • chrome plated • slotted stem • 1/2" MIP x 1/2" FIP integral stop 	IS - 23 - AS SHOWN	10	200
	<p>INTEGRAL STOP <i>FOR SHOWER VALVES</i></p> <ul style="list-style-type: none"> • chrome plated • slotted stem • 1/2" MIP x 1/2" SWT 	IS - 24 - AS SHOWN	10	200
	<p>MOUNTING BRACKET</p> <ul style="list-style-type: none"> • black ABS • shower valve mounting bracket 	TNS - BMK - AS SHOWN	1	1
	<p>SOAP DISPENSOR <i>FOR LIQUID SOAP</i></p> <ul style="list-style-type: none"> • chrome finish • available in brushed nickel and oil rubbed bronze 	LSD - 100 - AS SHOWN	1	50
		LSD - 100S - BRUSHED NICKEL	1	50
		LSD - 100ORB - OIL RUBBED BRONZE	1	50







IMAGE	DESCRIPTION	MODEL NO. / FINISH	INNER	MASTER
	<p>WATER FOUNTAIN</p> <ul style="list-style-type: none"> • 1/2" self closing bubbler 	SCV - 054 - AS SHOWN	1	40
		SCV - 054H - HEAVY DUTY	1	40
	<p>SELF CLOSING FAUCET</p> <ul style="list-style-type: none"> • 1/2" self closing basin faucet • hot, cold, and plain button 	SCB - 050 - AS SHOWN	1	36
	<p>SELF CLOSING VALVE</p> <ul style="list-style-type: none"> • 1/2" self closing valve • cross handle 	SCV - 050 - AS SHOWN	1	50
	<p>SELF CLOSING VALVE</p> <ul style="list-style-type: none"> • 1/2" self closing valve • lever handle 	SCV - 052 - AS SHOWN	1	50
	<p>SELF CLOSING VALVE</p> <ul style="list-style-type: none"> • 1/2" self closing valve • lever handle and chain 	SCV - 053 - AS SHOWN	1	50
	<p>SHOWER HEAD <i>SUNFLOWER</i></p> <ul style="list-style-type: none"> • 6" shower head • 1/2" FIP • rubber jets • chrome plated shower arm 	S - 800 - AS SHOWN	1	6
	<p>SHOWER HEAD <i>SUNFLOWER</i></p> <ul style="list-style-type: none"> • 8" shower head • 1/2" FIP • brass jets • chrome plated shower arm 	S - 900 - AS SHOWN	1	6
		S - 900s - BRUSHED NICKEL	1	6
		S - 900ORB - OIL RUBBED BRONZE	1	6
	<p>SHOWER HEAD <i>SUNFLOWER</i></p> <ul style="list-style-type: none"> • 6" shower head <u>only</u> • 1/2" FIP • brass jets 	S - 800H - AS SHOWN	1	6









IMAGE	DESCRIPTION	MODEL NO. / FINISH	INNER	MASTER		
	SHOWER HEAD SUNFLOWER <ul style="list-style-type: none"> • 8" shower head <u>only</u> • 1/2" FIP • brass jets 	S - 900H - AS SHOWN S - 900HS - SATIN NICKEL S - 900HORB - OIL RUBBED BRONZE	1 1 1	6 6 6		
		SHOWER ARM SUNFLOWER <ul style="list-style-type: none"> • 18" shower arm <u>only</u> • chrome plated • 1/2" FIP 	S - ARMC - AS SHOWN S - ARMS - BRUSHED NICKEL S - ARMORB - OIL RUBBED BRONZE S - ARM90c - 90° CHROME	1 1 1 1	6 6 6 6	
			SHOWERHEAD MISER <ul style="list-style-type: none"> • 1" showerhead • miser water saver • 1/2" FIP 	S - 050 - AS SHOWN	1	200
			SHOWERHEAD BALL JOINT <ul style="list-style-type: none"> • 2" showerhead • ball joint • 1/2" FIP 	S - 100 - AS SHOWN	1	200
		SHOWERHEAD BALL JOINT <ul style="list-style-type: none"> • chrome plate ABS • ball joint • 1/2" FIP • S-125WS = watersaver 1.5 GPM with pressure compensated flow restrictor 	S - 125 - AS SHOWN	1	200	
	S - 125ws - LOW FLOW - 1.5 GPM		1	200		
	SHOWERHEAD ADJUSTABLE <ul style="list-style-type: none"> • 2" showerhead • 1/2" FIP 	S - 400 - AS SHOWN	10	100		
		S - 500 - 3" SHOWERHEAD	10	50		
		S - 550 - 4" SHOWERHEAD	1	20		
	SHOWERHEAD DIE CAST ZINC <ul style="list-style-type: none"> • 1-3/4" showerhead • 1/2" FIP • chrome plated zinc die cast 	S - 106 - AS SHOWN	1	200		
	SHOWERHEAD PLAIN STYLE <ul style="list-style-type: none"> • 1-1/2" showerhead • 1/2" FIP • chrome plated zinc die cast 	S - 150 - AS SHOWN	1	100		











IMAGE	DESCRIPTION	MODEL NO. / FINISH	INNER	MASTER	
	<p>SHOWERHEAD <i>PLASTIC JETS</i></p> <ul style="list-style-type: none"> • 2" showerhead • 1/2" FIP • chrome plated zinc, die cast • with plastic jets 	S - 200 - AS SHOWN	1	100	
		S - 300 - 3" SHOWERHEAD	1	100	
	<p>SHOWERHEAD <i>MASSAGING</i></p> <ul style="list-style-type: none"> • 4" showerhead • 1/2" FIP 	M - 100 - AS SHOWN	1	48	
	<p>SHOWERHEAD <i>MASSAGING - FIXED</i></p> <ul style="list-style-type: none"> • 2-1/2" showerhead - fixed • chrome plated • 1/2" FIP 	M - 150 - AS SHOWN	3	24	
	<p>SHOWERHEAD <i>MASSAGING</i></p> <ul style="list-style-type: none"> • 2-1/2" showerhead • 1/2" FIP 	M - 250 - AS SHOWN	1	100	
	<p>SHOWERHEAD <i>MASSAGING</i></p> <ul style="list-style-type: none"> • 4" showerhead • chrome plated • 1/2" FIP 		M - 350 - AS SHOWN	1	50
			M - 350s - BRUSHED NICKEL	1	50
	<p>SHOWERHEAD <i>MASSAGING</i></p> <ul style="list-style-type: none"> • 4" showerhead • vinyl hose with chrome accents • with mounting bracket 	M - 200 - AS SHOWN	1	24	
	SHOWERHEAD ONLY	M - 300 - SHOWERHEAD ONLY	1	24	
	BRACKET ONLY	M - 210 - BRACKET ONLY	1	50	
	HOSE ONLY	VPC - 59 - 59" HOSE ONLY	1	100	



IMAGE	DESCRIPTION	MODEL NO. / FINISH	INNER	MASTER
	SHOWERHEAD KIT <i>COMPLETE HANDHELD KIT</i>	AS - AS SHOWN	1	24
	• showerhead with shut-off • wall bracket • 59" stainless steel hose • economical	B - 848PAR - HANDHELD SHOWER - HEAD, BRACKET - PARCHMENT	10	100
		BKT - WHT - BRACKET - WHITE	11	500
	SHOWER HOSE	CP - 59 - AS SHOWN	1	100
	• 59" stainless steel hose • chrome plated brass nuts • 1/2" FIP x 1/2" FIP	CP - 72 - 72" STAINLESS HOSE	1	100
	SHOWER HOSE	VHW - 59 - 59" WHITE VINYL HOSE	1	100
	• 59" white reinforced vinyl hose • chrome plated brass nuts • 1/2" FIP x 1/2" FIP	VHW - 72 - 72" WHITE VINYL HOSE	1	100
		VHW - 96 - 96" WHITE VINYL HOSE	1	100
	SHOWER DIVERTER <i>FOR HAND HELD</i>	DV - 841 - AS SHOWN	10	100
	• lever handle • chrome plated brass			
	SHOWER DIVERTER <i>FOR HAND HELD</i>	DV - 842 - AS SHOWN	1	500
	• push button • chrome plated ABS plastic			
	VOLUME CONTROL <i>FOR HAND HELD</i>	VC - 841 - AS SHOWN	20	200
	• chrome plated ABS plastic			
	SHOWER ARM	S - AB6 - AS SHOWN	10	200
	• 6" shower arm • chrome plated brass	S - AB8 - 8" SHOWER ARM	10	200
	SHOWER ARM	S - AB6F - AS SHOWN	10	200
	• 6" shower arm • with flange • chrome plated brass	S - AB8F - 8" SHOWER ARM WITH FLANGE	10	200
	CURTAIN ROD HOLDER	JCR - 650 - AS SHOWN	1	200
	• Jiffy flange			

IMAGE	DESCRIPTION	MODEL NO. / FINISH	INNER	MASTER
	<p>BATH SPOUT</p> <ul style="list-style-type: none"> • chrome plated brass • diverter spout • 3/4" FIP inlet in tail • with side outlet for shower hose 	FY-800SO - AS SHOWN	1	48
	<p>BATH SPOUT</p> <ul style="list-style-type: none"> • chrome plated brass • diverter spout • 3/4" FIP inlet in tail 	FY-801 - AS SHOWN	1	48
	<p>BATH SPOUT</p> <ul style="list-style-type: none"> • chrome plated die cast • diverter spout • 1/2" FIP inlet in nose 	FY-801DC - AS SHOWN FY-801DCS - BRUSHED NICKEL FY-801B - PVD BRASS	1	48
	<p>BATH SPOUT</p> <ul style="list-style-type: none"> • chrome plated brass • diverter spout • 1/2" FIP inlet in tail 	FY-802 - AS SHOWN FY-802S - BRUSHED NICKEL	1	48
	<p>BATH SPOUT</p> <ul style="list-style-type: none"> • chrome plated die cast • diverter spout • 1/2" FIP inlet in nose 	FY-803DC - AS SHOWN	1	50
	<p>BATH SPOUT</p> <ul style="list-style-type: none"> • chrome plated die cast • diverter spout • slip-on for 1/2" copper tubing 	FY-804DC - AS SHOWN FY-804DCS - BRUSHED NICKEL	1	50
	<p>BATH SPOUT</p> <ul style="list-style-type: none"> • chrome plated die cast • diverter spout • with decorative ring • slip-on for 1/2" copper tubing • matches Crescendo & Portia series 	FY-805DC - AS SHOWN FY-805DCS - BRUSHED NICKEL FY-805DCORB-C - OIL RUBBED BRONZE - MATCHES CRESCENDO SERIES FY-805DCORB-P - OIL RUBBED BRONZE - MATCHES PORTIA SERIES	1	50
	<p>BATH SPOUT</p> <ul style="list-style-type: none"> • chrome plated die cast • diverter spout • slip-on for 1/2" copper tubing • 5-3/4" long - ideal for garden tubs 	FY-806DCL - AS SHOWN	1	50
	<p>SPOUT REDUCTION</p> <ul style="list-style-type: none"> • bushing for spout reduction • 3/4" x 1/2" brass face bushing 	FB-101 - AS SHOWN	1	1000









IMAGE	DESCRIPTION	MODEL NO. / FINISH	INNER	MASTER
	<p>FAUCET HANDLES</p> <ul style="list-style-type: none"> • wrist blade handles • sold in pairs • for FT-300 & CT-800 Classic Elegance Kitchen & Lavatory faucets 	RH - 830WB - AS SHOWN	10	48
	<p>FAUCET HANDLES</p> <ul style="list-style-type: none"> • "jaws" fit all replacement • cross handles • sold in pairs 	RH - 7280 - AS SHOWN	10	100
	<p>FAUCET HANDLES</p> <ul style="list-style-type: none"> • "jaws" fit all replacement • lever handles • sold in pairs 	RH - 7290 - AS SHOWN	10	100
	<p>FAUCET HANDLES</p> <ul style="list-style-type: none"> • "jaws" fit all replacement • acrylic handles • sold in pairs 	RH - 8000 - AS SHOWN	10	100
	<p>FAUCET HANDLES</p> <ul style="list-style-type: none"> • chrome plated brass • cross handles • with wrench • sold in pairs • set screw "fit all" 	437100 - AS SHOWN	10	100
	<p>GERBER FAUCET HANDLES</p> <ul style="list-style-type: none"> • replacement handles • for Gerber style faucets • sold in pairs 	GH - 150 - AS SHOWN	1	50
	<p>GERBER STYLE BATH & SHOWER HANDLES</p> <ul style="list-style-type: none"> • replacement handles • for Gerber style bath & shower • sold in pairs 	GH - 300 - AS SHOWN	1	50
	<p>GERBER STYLE FAUCET STEMS</p> <ul style="list-style-type: none"> • for Gerber style faucet stem • hot 	STMG - 15H - FOR HOT STMG - 15C - FOR COLD	100	400

IMAGE	DESCRIPTION	MODEL NO. / FINISH	INNER	MASTER
	<p><u>GERBER STYLE SEAT</u></p> <ul style="list-style-type: none"> • Gerber style faucet seat • fits lavatory • fits bath & shower 	<p>GS - 100 - AS SHOWN</p>	<p>100</p>	<p>3000</p>
	<p><u>GERBER STYLE STEM</u></p> <ul style="list-style-type: none"> • Gerber style stem • hot & cold • fits TNS-500 bath & shower 	<p>STMG - 23 - AS SHOWN</p>	<p>25</p>	<p>100</p>
	<p><u>GERBER STYLE DIVERTER</u></p> <ul style="list-style-type: none"> • Gerber style stem • shower diverter • for TNS-500 bath & shower 	<p>STMG - 0458 - AS SHOWN</p>	<p>25</p>	<p>100</p>
	<p><u>PRICE PFISTER STYLE STEM</u></p> <ul style="list-style-type: none"> • hot & cold stem • for TNS-782 & TNS-783 two handle & three handle shower 	<p>STMP - 78 - AS SHOWN</p>	<p>25</p>	<p>100</p>
	<p><u>PRICE PFISTER STYLE DIVERTER</u></p> <ul style="list-style-type: none"> • for TNS- 783 bath & shower 	<p>STMP - 79D - AS SHOWN</p>	<p>25</p>	<p>100</p>
	<p><u>SAVOY STYLE STEM & SLEEVE</u></p> <ul style="list-style-type: none"> • Savoy style shower stem • chrome plated sleeve 	<p>STMY - 39C - AS SHOWN</p>	<p>25</p>	<p>100</p>
	<p><u>CENTRAL STYLE STEM</u></p> <ul style="list-style-type: none"> • Central style • bath & shower stem 	<p>STMC - 27 - AS SHOWN</p>	<p>25</p>	<p>100</p>









IMAGE	DESCRIPTION	MODEL NO. / FINISH	INNER	MASTER
	SHOWER CABINET VALVE			
	<ul style="list-style-type: none"> • 3-3/8" shower stall valve only 	SSV - 338 - AS SHOWN	1	24
	UTILITY SHOWER			
	<ul style="list-style-type: none"> • utility shower faucet complete • includes: soap dish, shower head, two metal cross handles, 18" rise shower arm 	UTF - 3 - AS SHOWN	1	6
	SINK SUPPLY HOSE			
	<ul style="list-style-type: none"> • stainless steel braid • 3/8" comp x 1/2" FIP 	{ SSF - 12 - 12" METAL NUT SSF - 20 - 20" METAL NUT SSF - 30 - 30" METAL NUT SSF - 36 - 36" METAL NUT	25	100
		ECONOMY		
		SSF - 12N - 12" METAL NUT	10	100
		SSF - 20N - 20" METAL NUT	10	100
		SSF - 30N - 30" METAL NUT	10	100
		SSF - 36N - 36" METAL NUT	10	100
	DELTA STYLE SUPPLY HOSE			
	<ul style="list-style-type: none"> • stainless steel • w/ nut & ferrule • 3/8" comp x 3/8" comp 	{ DDF - 12 - 12" LONG DDF - 20 - 20" LONG	25	100
		ECONOMY		
		DDF - 12N - 12" LONG	10	100
		DDF - 20N - 20" LONG	10	100
	CLOSET SUPPLY HOSE			
	<ul style="list-style-type: none"> • stainless steel braid • metal nut • 3/8" comp x 7/8" comp 	{ SST - 09M - 9" METAL NUT SST - 12M - 12" METAL NUT SST - 20M - 20" METAL NUT SST - 30M - 30" METAL NUT	25	100
		ECONOMY		
		SST - 09MN - 9" METAL NUT	10	100
		SST - 12MN - 12" METAL NUT	10	100
		SST - 20MN - 20" METAL NUT	10	100
	CLOSET SUPPLY HOSE			
	<ul style="list-style-type: none"> • stainless steel braid • plastic nut • 3/8" comp x 7/8" comp 	{ SST - 09P - 9" PLASTIC NUT SST - 12P - 12" PLASTIC NUT	25	100
		ECONOMY		
		SST - 09PN - 9" PLASTIC NUT	10	100
	SST - 12PN - 12" PLASTIC NUT	10	100	
	WASHING MACHINE HOSE			
	<ul style="list-style-type: none"> • washing machine connector • braided stainless steel 	SSWM - 48 - 48" LONG	1	60
		SSWM - 60 - 60" LONG	1	50
		SSWM - 72 - 72" LONG	1	30
	DISHWASHER HOSE			
	<ul style="list-style-type: none"> • dishwasher connector • with 90° brass elbow • braided stainless steel 	SSDW - 36 - 36" LONG	1	50
		SSDW - 48 - 48" LONG	1	40
		SSDW - 60 - 60" LONG	1	30
		SSDW - 72 - 72" LONG	1	30









IMAGE	DESCRIPTION	MODEL NO. / FINISH	INNER	MASTER
	<p>SINK STRAINER <i>FITS 3-1/2" - 4" OPENINGS</i></p> <ul style="list-style-type: none"> • 4-1/2" sink strainer • stainless steel 	SS - 100 - AS SHOWN	1	50
	<p>SINK STRAINER <i>FITS 3-1/2" - 4" OPENINGS</i></p> <ul style="list-style-type: none"> • 4-1/2" sink strainer • stainless steel • brushed nickel finish 	SS - 102s - AS SHOWN	1	50
	<p>SINK STRAINER <i>FITS 3-1/2" - 4" OPENINGS</i></p> <ul style="list-style-type: none"> • 4-1/2" sink strainer • stainless steel • with wing nuts • brass slip nut 	SS - 105 - AS SHOWN	1	50
	<p>SINK STRAINER <i>FITS 3-1/2" - 4" OPENINGS</i></p> <ul style="list-style-type: none"> • 4-1/2" sink strainer • stainless steel • double cup - economy 	SS - 111 - AS SHOWN	1	50
	<p>SINK STRAINER <i>FITS 3-1/2" - 4" OPENINGS</i></p> <ul style="list-style-type: none"> • 4-1/2" sink strainer • stainless steel • double cup 	SS - 112 - AS SHOWN	1	50
	<p>SINK STRAINER <i>FITS 3-1/2" - 4" OPENINGS</i></p> <ul style="list-style-type: none"> • 4-1/2" sink strainer • stainless steel • basket with spring clip • 3-3/8" extra heavy rubber washer • positive water seal 	SS - 145 - AS SHOWN	1	50
	<p>SINK STRAINER <i>FITS 3-1/2" - 4" OPENINGS</i></p> <ul style="list-style-type: none"> • 4-1/2" sink strainer • chrome plated • stamped brass 	SS - 125 - AS SHOWN	1	50
	<p>SINK STRAINER <i>FITS 3-1/2" - 4" OPENINGS</i></p> <ul style="list-style-type: none"> • 4-1/2" sink strainer • chrome plated • cast brass 	SS - 175 - AS SHOWN	1	25











IMAGE	DESCRIPTION	MODEL NO. / FINISH	INNER	MASTER
	<p>SINK STRAINER <i>FITS 3-1/2" - 4" OPENINGS</i></p> <ul style="list-style-type: none"> • 4-1/2" sink Duo strainer • stainless steel • double cup, Snaploc basket • brass slip nut 	SS - 185B - AS SHOWN	1	50
	<p>SINK STRAINER <i>FITS 3-1/2" - 4" OPENINGS</i></p> <ul style="list-style-type: none"> • 4-1/2" sink strainer • stainless steel • Twist 'n Seal 	SS - 195 - AS SHOWN	1	50
	<p>SINK STRAINER <i>FITS 3-1/2" - 4" OPENINGS</i></p> <ul style="list-style-type: none"> • 4-1/2" sink strainer • stainless steel clad plastic 	SS - 150 - AS SHOWN	1	50
	<p>SINK STRAINER <i>FITS 3-1/2" - 4" OPENINGS</i></p> <ul style="list-style-type: none"> • 4-1/2" sink strainer • flat top design • sink or shower stall 	SS - 400 - AS SHOWN	1	50
	<p>SINK STRAINER <i>FITS 1-7/8" - 2-1/2" OPENINGS</i></p> <ul style="list-style-type: none"> • 2-1/2" junior strainer • stainless steel duo basket 	SS - 600 - AS SHOWN	1	100
	<p>SINK STRAINER <i>FITS 1-7/8" - 2-1/2" OPENINGS</i></p> <ul style="list-style-type: none"> • 2-1/2" junior Duo strainer • chrome plated brass • deep pattern 	SS - 605 - AS SHOWN	1	100
	<p>SINK STRAINER <i>FITS 1-7/8" - 2-1/2" OPENINGS</i></p> <ul style="list-style-type: none"> • 2-1/2" stainless steel duplex strainer 	SS - 200 - AS SHOWN SS - 200MH - WITH GRID DRAIN	1 1	100 100
	<p>SINK STRAINER <i>FITS 1-7/8" - 2-1/2" OPENINGS</i></p> <ul style="list-style-type: none"> • 2-1/2" stainless steel • wash tray design • with rubber stopper 	SS - 300 - AS SHOWN	1	100
	<p>SINK STRAINER <i>REPLACEMENT INSERTS</i></p> <ul style="list-style-type: none"> • for 4-1/2" strainer • fits all basket with rubber seat • plastic post type 	SS - 500 - AS SHOWN	1	100
	<p>SINK STRAINER <i>REPLACEMENT INSERTS</i></p> <ul style="list-style-type: none"> • for 4-1/2" strainer • fits all basket with rubber seat • metal post type 	SS - 500M - AS SHOWN	1	100

IMAGE	DESCRIPTION	MODEL NO. / FINISH	INNER	MASTER
	<p>SINK STRAINER REPLACEMENT INSERTS</p> <ul style="list-style-type: none"> • for ss-100 and ss-111 	SS - 510 - AS SHOWN	1	100
	<p>SINK STRAINER REPLACEMENT INSERTS</p> <ul style="list-style-type: none"> • for ss-112 	SS - 512 - AS SHOWN	1	100
	<p>SINK STRAINER REPLACEMENT INSERTS</p> <ul style="list-style-type: none"> • for ss-125 	SS - 525 - AS SHOWN	1	100
	<p>SINK STRAINER REPLACEMENT INSERTS</p> <ul style="list-style-type: none"> • for ss-175 	SS - 575 - AS SHOWN	1	100
	<p>SINK STRAINER REPLACEMENT INSERTS</p> <ul style="list-style-type: none"> • for ss-195 	SS - 595 - AS SHOWN	1	100
	<p>SINK STRAINER REPLACEMENT INSERTS</p> <ul style="list-style-type: none"> • for ss-600 	SS - 610 - AS SHOWN	1	100
	<p>SINK STRAINER REPLACEMENT INSERTS</p> <ul style="list-style-type: none"> • for ss-605 	SS - 615 - AS SHOWN	1	100
	<p>SINK STRAINER REPLACEMENT INSERTS</p> <ul style="list-style-type: none"> • for ss-185B 	SS - 585 - AS SHOWN	1	100





IMAGE	DESCRIPTION	MODEL NO. / FINISH	INNER	MASTER
	<p><u>POP-UP ASSEMBLY</u></p> <ul style="list-style-type: none"> • chrome plated brass • with lift rod 	<p>FY - 950 - AS SHOWN</p> <p>FY - 951 - IAPMO APPROVED</p> <p>FY - 951S - BRUSHED NICKEL</p> <p>FY - 951B - PVD BRASS</p> <p>FY - 951ORB-C-CRESCENDO COLLECTION</p> <p>FY - 951ORB-P-POSITANO COLLECTION</p>	<p>1</p> <p>1</p> <p>1</p> <p>1</p> <p>1</p> <p>1</p>	<p>24</p> <p>24</p> <p>24</p> <p>24</p> <p>24</p> <p>24</p>
	<p><u>POP-UP ASSEMBLY</u></p> <ul style="list-style-type: none"> • chrome plated brass • with plastic tail piece • with lift rod 	<p>FY - 952 - AS SHOWN</p>	<p>1</p>	<p>48</p>
	<p><u>SINK DRAIN ASSEMBLY</u></p> <ul style="list-style-type: none"> • chrome plated brass • 2 piece P.O. plug • with chain and stopper 	<p>FY - 925 - AS SHOWN</p>	<p>1</p>	<p>50</p>
	<p><u>SINK DRAIN ASSEMBLY</u></p> <ul style="list-style-type: none"> • chrome plated brass • grid top • P.O. plug • 17 gauge • 4" tail piece 	<p>FY - 155 - AS SHOWN</p> <p>FY - 156 - 6" TAIL PIECE</p> <p>FY - 155TP - 6" TAIL PIECE ONLY</p>	<p>1</p> <p>1</p> <p>1</p>	<p>100</p> <p>100</p> <p>1</p>
	<p><u>SINK DRAIN ASSEMBLY</u></p> <ul style="list-style-type: none"> • chrome plated brass • grid top • P.O. plug • 17 gauge offset • wheel chair 	<p>FY - 159WC - AS SHOWN</p>	<p>1</p>	<p>50</p>







IMAGE	DESCRIPTION	MODEL NO. / FINISH	INNER	MASTER
	<p>SHOWER DRAIN</p> <ul style="list-style-type: none"> • 2" die cast, brass plated body • stainless steel grid • quick connect • rubber gasket 	SDBC - 200 - AS SHOWN	1	40
	<p>SHOWER DRAIN</p> <ul style="list-style-type: none"> • 2" brass body • stainless steel snap-in grid • no caulk • wrench included 	SDB2NC - AS SHOWN	1	20
	<p>SHOWER DRAIN</p> <ul style="list-style-type: none"> • 2" white plastic body • stainless steel grid • quick caulk • wrench included 	SDP2WSS - AS SHOWN	1	40
	<p>SHOWER DRAIN</p> <ul style="list-style-type: none"> • 2" black plastic body • stainless steel snap-in grid • quick caulk • wrench included 	SDP2BSS - AS SHOWN	1	40
	<p>SHOWER DRAIN</p> <ul style="list-style-type: none"> • 2" solvent weld • white plastic • stainless steel grid 	SDP2WSW - AS SHOWN	1	40
	<p>SHOWER DRAIN</p> <ul style="list-style-type: none"> • PVC shower drain • adjustable strainer • stainless steel grid 	SDPVC2 - AS SHOWN	1	1
	<p>DROP EAR ELBOW</p> <ul style="list-style-type: none"> • bronze • sizes as indicated 	<p>DE - 0303 - 1/2" FIP X 1/2" SWT</p> <p>DE - 0304 - 1/2" FIP X 3/4" SWT</p> <p>DE - 0403 - 3/4" FIP X 1/2" SWT</p> <p>DE - 0404 - 3/4" FIP X 3/4" SWT</p> <p>PXLD0303 - 1/2" FIP X 1/2" PEX</p>	<p>25</p> <p>25</p> <p>25</p> <p>25</p> <p>25</p>	<p>250</p> <p>250</p> <p>250</p> <p>250</p> <p>250</p>







IMAGE	DESCRIPTION	MODEL NO. / FINISH	INNER MASTER
	<p>BATHCOCK <i>FOR CLAWFOOT TUBS</i></p> <ul style="list-style-type: none"> • chrome plated brass • # 3 bath faucet • 3-3/8" centers 	<p>FY - 775 - AS SHOWN</p>	<p>1 40</p>
	<p>BATHCOCK <i>FOR CLAWFOOT TUBS</i></p> <ul style="list-style-type: none"> • chrome plated brass • # 0 bath faucet 	<p>FY - 750 - AS SHOWN</p>	<p>1 24</p>
	<p>BATHCOCK ELBOW <i>FOR CLAWFOOT TUBS</i></p> <ul style="list-style-type: none"> • 1/2" UNION x 1/2" MIP • sold in pairs 	<p>BCL - 050 - AS SHOWN</p>	<p>1 72</p>
	<p>BATH FAUCET <i>FOR CLAWFOOT TUBS</i></p> <ul style="list-style-type: none"> • chrome plated brass • code pattern 	<p>FY - 850 - AS SHOWN</p>	<p>1 24</p>
	<p>FAUCET <i>SINGLE BASIN FAUCET</i></p> <ul style="list-style-type: none"> • chrome plated • with removable seat • hot & cold buttons 	<p>FY - 700 - AS SHOWN</p>	<p>6 72</p>
	<p>FAUCET <i>SINGLE BASIN FAUCET</i></p> <ul style="list-style-type: none"> • chrome plated • extra heavy pattern • with aerator • hot & cold buttons 	<p>FY - 700x - AS SHOWN</p>	<p>1 30</p>









IMAGE	DESCRIPTION	MODEL NO. / FINISH	INNER	MASTER
	HOSE BIBB			
	<ul style="list-style-type: none"> • chrome plated brass • tee handle • hose end outlet • 1/2" MIP inlet 	FY - 690 - AS SHOWN	12	72
		FY - 690RC - ROUGH CHROME	12	72
		FY - 691 - PLAIN END OUTLET	12	72
	HOSE BIBB			
	<ul style="list-style-type: none"> • chrome plated brass • tee handle • hose end outlet • 3/4" MIP inlet 	FY - 695 - AS SHOWN	12	72
	HOSE BIBB			
	<ul style="list-style-type: none"> • chrome plated • 1/2" hose end outlet • 1/2" FIP inlet 	FY - 685 - AS SHOWN	12	72
	HOSE BIBB			
	<ul style="list-style-type: none"> • chrome plated brass • tee handle • hose end outlet • 1/2" FIP inlet - flanged 	FY - 680 - AS SHOWN	12	72
		FY - 675 - PLAIN END OUTLET	12	72
		FY - 686 - ROUGH BRASS	12	72
	HOSE BIBB			
	<ul style="list-style-type: none"> • no kink • 3/4" hose outlet • available in IPS & sweat 	207TF - FEMALE END - AS SHOWN	12	72
		207TM - MALE END	12	72
	HOSE BIBB			
	<ul style="list-style-type: none"> • rough brass • tee handle • plain end outlet • 1/2" MIP inlet 	FY - 692 - AS SHOWN	12	72
	HOSE BIBB			
	<ul style="list-style-type: none"> • chrome plated • tee handle • plain end outlet • 1/2" MIP inlet • adjustable flange 	FY - 681 - AS SHOWN	12	72
		FY - 682 - HOSE END OUTLET	12	72
	HOSE BIBB			
	<ul style="list-style-type: none"> • ball valve hose bibb • 1/4 turn • 3/4" hose outlet 	646BV - AS SHOWN	12	72
	HOSE BIBB			
	<ul style="list-style-type: none"> • rough brass • male • hose outlet 	646R - AS SHOWN	12	72





IMAGE	DESCRIPTION	MODEL NO. / FINISH	INNER	MASTER
	<p>SUPPLY VALVE</p> <ul style="list-style-type: none"> • chrome plated • quarter turn • angled • 3/8" FIP x 3/8" OD COMP 	25 - 1001 - AS SHOWN	12	72
	<p>SUPPLY VALVE</p> <ul style="list-style-type: none"> • chrome plated • quarter turn • angled • 1/2" FIP x 3/8" OD COMP 	25 - 1003 - AS SHOWN	24	144
	<p>SUPPLY VALVE</p> <ul style="list-style-type: none"> • chrome plated • quarter turn • angled • 1/2" SWT x 3/8" OD COMP 	25 - 1009 - AS SHOWN	24	144
	<p>SUPPLY VALVE</p> <ul style="list-style-type: none"> • chrome plated • quarter turn • angled • 1/2" NOM COMP x 3/8" OD COMP 	25 - 1019 - AS SHOWN	24	144
	<p>SUPPLY VALVE</p> <ul style="list-style-type: none"> • chrome plated • quarter turn • straight • 3/8" FIP x 3/8" OD COMP 	25 - 1002 - AS SHOWN	24	144
	<p>SUPPLY VALVE</p> <ul style="list-style-type: none"> • chrome plated • quarter turn • straight • 1/2" FIP x 3/8" OD COMP 	25 - 1004 - AS SHOWN	24	144
	<p>SUPPLY VALVE</p> <ul style="list-style-type: none"> • chrome plated • quarter turn • straight • 1/2" SWT x 3/8" OD COMP 	25 - 1010 - AS SHOWN	24	144
	<p>SUPPLY VALVE</p> <ul style="list-style-type: none"> • chrome plated • quarter turn • straight • 1/2" NOM COMP x 3/8" OD COMP 	25 - 1014 - AS SHOWN	24	144

IMAGE	DESCRIPTION	MODEL NO. / FINISH	INNER	MASTER
	<p>SUPPLY VALVE</p> <ul style="list-style-type: none"> • chrome plated <i>RETRO-FIT</i> • quarter turn • straight • 3/8" OD captured nut x 3/8" OD COMP 	25 - 2000 - AS SHOWN	24	144
	<p>SUPPLY VALVE</p> <ul style="list-style-type: none"> • chrome plated • universal • quarter turn • angled • 1/2" OD COMP x 3/8" OD COMP 	25 - 1019uv - AS SHOWN	24	144
	<p>SUPPLY VALVE</p> <ul style="list-style-type: none"> • chrome plated • quarter turn • angled • 1/2" PEX x 3/8" OD 	25 - 1003px - AS SHOWN	24	144
	<p>SUPPLY VALVE</p> <ul style="list-style-type: none"> • chrome plated • quarter turn • straight • 1/2" PEX x 3/8" OD 	25 - 1004px - AS SHOWN	24	144
	<p>SUPPLY VALVE</p> <ul style="list-style-type: none"> • chrome plated • quarter turn • straight • oval handle • 3/8" FIP x 3/8" OD COMP 	26 - 1002 - AS SHOWN	24	144
	<p>SUPPLY VALVE</p> <ul style="list-style-type: none"> • chrome plated • quarter turn • straight • oval handle • 1/2" FIP x 3/8" OD COMP 	26 - 1004 - AS SHOWN	24	144
	<p>SUPPLY VALVE</p> <ul style="list-style-type: none"> • chrome plated • quarter turn • straight • oval handle • 1/2" SWEAT x 3/8" OD COMP 	26 - 1010 - AS SHOWN	24	144
	<p>SUPPLY VALVE</p> <ul style="list-style-type: none"> • chrome plated • quarter turn • straight • oval handle • 5/8" OD COMP x 3/8" OD COMP 	26 - 1014 - AS SHOWN	24	144

















IMAGE	DESCRIPTION	MODEL NO. / FINISH	INNER	MASTER
	<p>SUPPLY VALVE </p> <ul style="list-style-type: none"> • quarter turn • angle • oval handle • 1/2" PEX x 3/8" OD COMP 	26 - 1003PX - AS SHOWN	24	144
	<p>SUPPLY VALVE </p> <ul style="list-style-type: none"> • quarter turn • straight • oval handle • 1/2" PEX x 3/8" OD COMP 	26 - 1004PX - AS SHOWN	24	144
	<p>SUPPLY VALVE </p> <ul style="list-style-type: none"> • quarter turn • angle • oval handle • 3/8" FIP x 3/8" OD COMP 	26 - 1001 - AS SHOWN	24	144
	<p>SUPPLY VALVE </p> <ul style="list-style-type: none"> • quarter turn • angle • oval handle • 1/2" FIP x 3/8" OD COMP 	26 - 1003 - AS SHOWN	24	144
	<p>SUPPLY VALVE </p> <ul style="list-style-type: none"> • quarter turn • angle • oval handle • 1/2" SWEAT x 3/8" OD COMP 	26 - 1009 - AS SHOWN	24	144
	<p>SUPPLY VALVE </p> <ul style="list-style-type: none"> • quarter turn • angle • oval handle • 5/8" OD COMP x 3/8" OD COMP 	26 - 1019 - AS SHOWN	24	144
	<p>SUPPLY VALVE </p> <ul style="list-style-type: none"> • chrome plated 5" tube & escutcheon • quarter turn • straight • oval handle • 1/2" SWEAT x 3/8" OD COMP 	26 - 1040 - AS SHOWN	24	144
	<p>SUPPLY VALVE </p> <ul style="list-style-type: none"> • chrome plated 5" tube & escutcheon • quarter turn • angle • oval handle • 1/2" SWEAT x 3/8" OD COMP 	26 - 1041 - AS SHOWN	24	144

















IMAGE	DESCRIPTION	MODEL NO. / FINISH	INNER	MASTER
	<p>SUPPLY VALVE</p> <ul style="list-style-type: none"> • quarter turn • dual valve • oval handle • 5/8" OD COMP x 3/8" OD COMP 	<p>26 - 2001 - AS SHOWN</p>  	10	200
	<p>SUPPLY VALVE</p> <ul style="list-style-type: none"> • chrome plated • compression • angle • 1/2" PEX x 3/8" OD COMP 	<p>29 - 1003PX - AS SHOWN</p> 	10	200
	<p>SUPPLY VALVE</p> <ul style="list-style-type: none"> • chrome plated • compression • straight • 1/2" PEX x 3/8" OD COMP 	<p>29 - 1004PX - AS SHOWN 29 - 1004 - 1/2" IPS X 3/8" OD - STRAIGHT</p> 	10 10	200 200
	<p>SUPPLY VALVE</p> <ul style="list-style-type: none"> • chrome plated • compression • angle • 3/8" FIP x 3/8" OD COMP 	<p>29 - 1001 - AS SHOWN 29 - 1001N - ECONOMY</p> 	10 10	200 200
	<p>SUPPLY VALVE</p> <ul style="list-style-type: none"> • chrome plated • compression • angle • 1/2" FIP x 3/8" OD COMP 	<p>29 - 1003 - AS SHOWN 29 - 1003B - UNPLATED 29 - 1003PX - PEX 29 - 1003N - ECONOMY</p> 	10 10 10 10	200 200 200 200
	<p>SUPPLY VALVE</p> <ul style="list-style-type: none"> • chrome plated • compression • angle • 1/2" SWT x 3/8" OD COMP 	<p>29 - 1009 - AS SHOWN 29 - 1009B - UNPLATED 29 - 1009N - ECONOMY</p> 	10 10 10	200 200 200
	<p>SUPPLY VALVE</p> <ul style="list-style-type: none"> • chrome plated • compression • angle • 5/8" OD COMP x 3/8" OD COMP 	<p>29 - 1019 - AS SHOWN 29 - 1019B - UNPLATED 29 - 1019N - ECONOMY</p> 	10 10 10	200 200 200
	<p>SUPPLY VALVE</p> <ul style="list-style-type: none"> • chrome plated • compression • angle • 5" extension with bell escutcheon • 1/2" SWT x 3/8" OD COMP 	<p>29 - 1040 - AS SHOWN</p> 	1	100









IMAGE	DESCRIPTION	MODEL NO. / FINISH	INNER	MASTER
	<p>SUPPLY VALVE</p> <ul style="list-style-type: none"> • chrome plated • dual outlet • angle • 5/8" OD x 3/8" OD x 3/8" OD 	29 - 2001 - AS SHOWN	10	200
	<p>SUPPLY VALVE</p> <ul style="list-style-type: none"> • chrome plated • flare outlet • angle • 1/2" FIP x 3/8" OD flare 	29 - 2050 - 1/2" FIP X 3/8" OD FLARE 29 - 2060 - 1/2" FIP X 1/2" OD FLARE	10	200
	<p>SUPPLY VALVE</p> <ul style="list-style-type: none"> • chrome plated • compression • straight • 3/8" FIP x 3/8" OD COMP 	29 - 1002 - 3/8" FIP X 3/8" OD 29 - 1004 - 1/2" FIP X 3/8" OD	10	200
	<p>SUPPLY VALVE</p> <ul style="list-style-type: none"> • chrome plated • compression • straight • 1/2" SWT x 3/8" OD COMP 	29 - 1010 - AS SHOWN 29 - 1010B - UNPLATED	10	200
	<p>SUPPLY VALVE</p> <ul style="list-style-type: none"> • chrome plated • compression • straight • 5/8" OD COMP x 3/8" OD COMP 	29 - 1014 - AS SHOWN	10	200
	<p>SUPPLY VALVE</p> <ul style="list-style-type: none"> • chrome plated • compression • straight • 1/2" OD COMP x 3/8" OD COMP 	29 - 1020 - AS SHOWN	10	200
	<p>SUPPLY VALVE</p> <ul style="list-style-type: none"> • chrome plated • compression • 1/2" SWT x 3/8" OD COMP • straight • 5" extension with bell escutcheon 	29 - 1041 - AS SHOWN	10	200
	<p>SUPPLY VALVE</p> <ul style="list-style-type: none"> • chrome plated • compression • 5/8" OD COMP x 5/8" OD COMP 	29 - 1575 - AS SHOWN	10	200

IMAGE	DESCRIPTION	MODEL NO. / FINISH	INNER	MASTER
	<p>WASHING MACHINE VALVE</p> <ul style="list-style-type: none"> • bronze • with lever • dual 1/2" IPS inlet • dual hose outlet 	WSI-050 - AS SHOWN	1	40
	<p>WASHING MACHINE VALVE</p> <ul style="list-style-type: none"> • bronze • with lever • dual 1/2" SWT inlet • dual hose outlet 	WSC-051 - AS SHOWN	1	40
	<p>WASHING MACHINE VALVE</p> <ul style="list-style-type: none"> • nickel plated • with tee handle • 1/2" COMP inlet • hose outlet 	205-WCMP - AS SHOWN	1	72
	<p>WASHING MACHINE VALVE</p> <ul style="list-style-type: none"> • nickel plated • with tee handle • 1/2" MIP inlet • hose outlet 	205-WMC - AS SHOWN	12	72
	<p>WASHING MACHINE TEE</p> <ul style="list-style-type: none"> • cast brass • 1-1/2" FIP X 1-1/2" MIP 	WTI-75 - 3/4" MIP X 1/2" FIP	10	100
		WTI-77 - 3/4" HOSE X 1/2" FIP	10	100
		WTI-78 - 3/4" HOSE X 1/2" SWT	10	100
	<p>WASHING MACHINE TEE</p> <ul style="list-style-type: none"> • cast brass • 1-1/2" MIP X 1-1/2" solder joint • Robinson tee 	WTS-80 - 3/4" MIP X 1/2" FIP	10	100
		WTS-82 - 3/4" HOSE X 1/2" FIP	10	100
		WTS-83 - 3/4" HOSE X 1/2" SWT	10	100
	<p>WASHING MACHINE TWIN MIX CONNECTOR</p> <ul style="list-style-type: none"> • twin mix connector • 3/4" galvanized 	TMX-075 - AS SHOWN	1	500
	<p>DISH WASHER TAIL PIECE</p> <ul style="list-style-type: none"> • 1/2" x 12" flanged • 22 gauge, brass nut 	DTP-100 - 1/2" OUTLET	1	50
		DTP-200 - 3/4" OUTLET	1	50
		DTP-300 - 3/4" HOSE THREAD OUTLET	1	50
	<p>DISH WASHER AIR GAP</p> <ul style="list-style-type: none"> • air gap - IAPMO 	AG-007 - AS SHOWN	1	50
	<p>DISH WASHER DISPOSAL CONNECTOR</p> <ul style="list-style-type: none"> • 4 clamp disposal connector 	DDC-100 - AS SHOWN	50	200

IMAGE	DESCRIPTION	MODEL NO. / FINISH	INNER	MASTER
	<p><u>SADDLE VALVE</u></p> <ul style="list-style-type: none"> • brass • standard • fits 1/2" tube • 1/4" OD compression outlet 	<p>BSV - 100 - AS SHOWN</p> <p>BSV - 200 - SELF PIERCING</p>	<p>1</p> <p>1</p>	<p>24</p> <p>24</p>
	<p><u>TOILET TANK TRIM</u></p> <ul style="list-style-type: none"> • brass elevated ballcock • with refill tube • clip • float rod 	<p>T - 100 - AS SHOWN</p>	<p>1</p>	<p>50</p>
	<p><u>TOILET TANK TRIM</u></p> <ul style="list-style-type: none"> • brass Douglas flush valve • with guide arm 	<p>T - 250 - AS SHOWN</p>	<p>2</p>	<p>50</p>
	<p><u>TOILET TANK TRIM</u></p> <ul style="list-style-type: none"> • chrome plated handle • single action tank lever 	<p>T - 300M - AS SHOWN</p> <p>T - 300MB - INDIVIDUAL BOX</p>	<p>50</p> <p>1</p>	<p>200</p> <p>100</p>
	<p><u>BATH WASTE & OVERFLOW</u> <i>EXTRA HEAVY PATTERN</i></p> <ul style="list-style-type: none"> • brass • 1-1/2" trip lever • with grid drain 	<p>TWB - 100 - AS SHOWN</p>	<p>1</p>	<p>12</p>
	<p><u>BATH WASTE & OVERFLOW</u> <i>EXTRA HEAVY PATTERN</i></p> <ul style="list-style-type: none"> • brass • 1-1/2" lift & turn 	<p>TWB - 200 - AS SHOWN</p>	<p>1</p>	<p>10</p>





IMAGE	DESCRIPTION	MODEL NO. / FINISH	INNER MASTER
	<p><u>BATH WASTE & OVERFLOW</u> <i>EXTRA HEAVY PATTERN</i></p> <ul style="list-style-type: none"> • brass • 1-1/2" touch toe 	<p>TWB - 300 - AS SHOWN</p>	<p>1 10</p>
	<p><u>BATH WASTE & OVERFLOW</u> <i>EXTRA HEAVY PATTERN</i></p> <ul style="list-style-type: none"> • brass • 1-1/2" pop-up drain 	<p>TWB - 605 - AS SHOWN</p>	<p>1 12</p>
	<p><u>BATH WASTE & OVERFLOW</u></p> <ul style="list-style-type: none"> • polypropylene • trip lever 	<p>TWB - 150 - AS SHOWN</p>	<p>1 12</p>
	<p><u>BATH WASTE & OVERFLOW</u></p> <ul style="list-style-type: none"> • polypropylene • lift lock 	<p>TWB - 250 - AS SHOWN</p>	<p>1 12</p>
	<p><u>BATH WASTE & OVERFLOW</u></p> <ul style="list-style-type: none"> • polypropylene • easy touch 	<p>TWB - 350 - AS SHOWN</p>	<p>1 12</p>









IMAGE	DESCRIPTION	MODEL NO. / FINISH	INNER	MASTER
	<u>BATH DRAIN PARTS</u>			
	<ul style="list-style-type: none"> • 1-1/2" chrome plated • die cast • lift & turn drain 	LNT - 151 - AS SHOWN	1	48
		LNT - 152 - LIFT & TURN - BRASS	1	100
	<u>BATH DRAIN PARTS</u>			
	<ul style="list-style-type: none"> • 1-1/2" chrome plated • brass • touch toe drain 	TTD - 150 - AS SHOWN	1	100
	<u>STANDING WASTE</u>			
	<ul style="list-style-type: none"> • 1-1/2" male • brass 	41375 - 1-1/2" MALE	1	10
		41380 - 1-1/2" FEMALE	1	10
		41390 - 1-1/2" MALE/FEMALE COMBO	1	10
	<u>STANDING WASTE</u>			
	<ul style="list-style-type: none"> • 1-1/2" shoe 	SBW - 07 - AS SHOWN	2	24
	<u>STANDING WASTE</u>			
	<ul style="list-style-type: none"> • plunger assembly 	SBW - 08 - AS SHOWN	2	50
	<u>STANDING WASTE</u>			
	<ul style="list-style-type: none"> • chrome plated barrel only 	SBW - 09 - AS SHOWN	2	50
	<u>URINAL SPUDS</u>			
	<ul style="list-style-type: none"> • cast brass • heavy mack washer • friction ring 	SP - 125 - 1-1/4" x 1-1/4"	20	200
		SP - 175 - 1" x 3/4"	15	150
		SP - 1275 - 1-1/4" x 3/4"	25	150
	<u>CLOSET SPUDS</u>			
	<ul style="list-style-type: none"> • cast brass • heavy mack washer • friction ring 	SP - 152 - 1-1/2" x 1-1/4"	25	125
		SP - 155 - 1-1/2" x 1-1/2"	25	125
		SP - 225 - 2" x 1-1/4"	10	100
		SP - 250 - 2" x 1-1/2"	10	100
		SP - 200 - 2" x 2"	10	100



IMAGE	DESCRIPTION	MODEL NO. / FINISH	INNER	MASTER
	CLOSET FLANGES <ul style="list-style-type: none"> • cast brass • 4" flange 	CF - 100 - AS SHOWN	1	50
	CLOSET FLANGES <ul style="list-style-type: none"> • cast brass • 4" x 3" DWV for sweat 	CF - 200 - AS SHOWN	1	50
	CLOSET FLANGES <ul style="list-style-type: none"> • cast brass • 3" DWV - shallow 	CF - 250 - AS SHOWN	1	50
	CLOSET FLANGES <ul style="list-style-type: none"> • cast brass • 4" deep seal 	CF - 300 - AS SHOWN	1	50
	CLOSET FLANGES <ul style="list-style-type: none"> • cast brass • 4" x 3" for lead 	CF - 400 - AS SHOWN	1	50
	CLOSET FLANGES <ul style="list-style-type: none"> • cast brass • 4" offset 	CF - 500 - AS SHOWN	10	60
	CLOSET FLANGES <ul style="list-style-type: none"> • cast iron • no caulk • with stainless steel nuts & bolts • no hub connection 	CFCI - 320 - 3" x 2" CFCI - 420 - 4" x 2" CFCI - 430 - 4" x 3" CFCI - 440 - 4" x 4"	1 1 1 1	200 200 200 200
	CLOSET FLANGES <ul style="list-style-type: none"> • cast iron • caulk connection 	FCI - 420 - 4" x 2" FCI - 420 - H - 4" x 2-1/2" EXTRA HEAVY	1 1 1	8 8 8
	CLOSET BENDS <ul style="list-style-type: none"> • cast iron • no hub 	CICB - 1116 - 4" x 16" CICB - 116515 - 4" x 6" x 15"	1 1	50 25









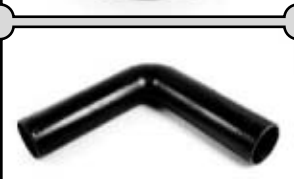











IMAGE	DESCRIPTION	MODEL NO. / FINISH	INNER	MASTER
	<p>TRAP</p> <ul style="list-style-type: none"> • 17 gauge <i>SEMI CAST</i> • cast brass J-bend • 1-1/2" x 1-1/4" • with brass coupling nuts 	TRAP - 8902 - 1-1/2" x 1-1/4"	1	24
		TRAP - 8912 - 1-1/2" x 1-1/2"	1	24
		TRAP - 8872 - 1-1/4" x 1-1/4"	1	24
	<p>TRAP</p> <ul style="list-style-type: none"> • chrome plated cast brass • LA trap - IPS • 1-1/2" x 1-1/4" • with cleanout 	TRAP - A - AS SHOWN	1	25
	<p>TRAP</p> <ul style="list-style-type: none"> • chrome plated cast brass • LA trap - IPS • 1-1/2" x 1-1/4" • less cleanout 	TRAP - B - AS SHOWN	1	25
	<p>TRAP</p> <ul style="list-style-type: none"> • rough brass • LA trap - sweat • 1-1/2" x 1-1/2" • less cleanout 	TRAP - C - AS SHOWN	1	25
	<p>TRAP</p> <ul style="list-style-type: none"> • rough brass • LA trap - IPS • 1-1/2" x 1-1/4" • with cleanout 	TRAP - D - AS SHOWN	1	25
	<p>TRAP</p> <ul style="list-style-type: none"> • rough brass • LA trap - IPS • 1-1/2" x 1-1/2" • less cleanout 	TRAP - E - AS SHOWN	1	25
	<p>TRAP</p> <ul style="list-style-type: none"> • rough brass • NY trap - IPS • 1-1/2" x 1-1/4" • with cleanout 	TRAP - F - AS SHOWN	1	25
	<p>TRAP</p> <ul style="list-style-type: none"> • chrome plated • NY trap - IPS • 1-1/2" x 1-1/4" • with cleanout 	TRAP - G - AS SHOWN	1	25
	<p>TRAP</p> <ul style="list-style-type: none"> • rough brass • NY trap - IPS • 2" x 1-1/2" • with cleanout 	TRAP - H - AS SHOWN	1	20
	<p>TRAP</p> <ul style="list-style-type: none"> • rough brass • NY trap - sweat • 2" x 1-1/2" • with cleanout 	TRAP - I - AS SHOWN	1	25

IMAGE	DESCRIPTION	MODEL NO. / FINISH	INNER	MASTER
	TRAP <ul style="list-style-type: none"> • rough brass • swing tee trap - IPS • 2" x 1-1/2" • with cleanout 	TRAP - J - AS SHOWN	1	25
	TRAP <ul style="list-style-type: none"> • rough brass • low seal trap - IPS • 1-1/2" x 1-1/2" • less cleanout 	TRAP - L - AS SHOWN	1	25
	TRAP <ul style="list-style-type: none"> • chrome plated • NY trap - IPS • 2" x 1-1/2" • with cleanout 	TRAP - M - AS SHOWN	1	25
	TRAP <ul style="list-style-type: none"> • rough brass • LA trap - IPS • 2" x 1-1/2" • with cleanout 	TRAP - N - AS SHOWN	1	20
	TRAP <ul style="list-style-type: none"> • rough brass • LA trap • 2" x 1-1/2" • sweat with cleanout 	TRAP - Q - AS SHOWN	1	20
	CAST IRON TRAP <ul style="list-style-type: none"> • low seal bath trap • 1-1/2" • less cleanout 	LST - 150 - AS SHOWN LST - 201 - 2" LOW SEAL LESS CLEANOUT	1 1	18 28
	SLIP NUTS <ul style="list-style-type: none"> • cast roughbrass -(R) • chrome plated -(C) 	NT - 125R - 1-1/4" x 1-1/4" NT - 152R - 1-1/2" x 1-1/4" NT - 155R - 1-1/2" x 1-1/2" NT - 125C - 1-1/4" x 1-1/4" NT - 152C - 1-1/2" x 1-1/4" NT - 155C - 1-1/2" x 1-1/2"	250 250 250 250 250 250	500 500 500 500 500 500
	PVC SINK DRAINS <ul style="list-style-type: none"> • 1-1/2" x 12" flair tail 	MNFT - 150 - 1-1/2" x 12"	1	100
	PVC SINK DRAINS <ul style="list-style-type: none"> • flexiable • connector - coupler 	MNCE - 555 - 1-1/2" x 12"	1	100
	PVC SINK DRAINS <ul style="list-style-type: none"> • flexiable • 1-1/4" x 9" slip joint 	MNSN - 125 - 1-1/4" x 9" MNSN - 150 - 1-1/2" x 12"	1 1	100 100

Limited Lifetime Warranty

All parts of the **Matco-Norca** faucet are warranted to the original consumer purchaser to be free of defects in material and workmanship. This warranty is made to the original consumer purchaser and shall be effective from the date of purchase as shown on purchaser's receipt.

Matco-Norca will replace, free of charge, during the warranty period, any part which proves defective in material and/or workmanship under normal installation, use and service. **Matco-Norca's** obligation under this warranty shall be limited to the replacement of any parts which proves defective upon **Matco-Norca's** inspection of such product. Replacement parts can be obtained by returning the defective part to your local **Matco-Norca** dealer, transportation charges prepaid, with a copy of the purchase receipt or by calling 800-431-2082.

This warranty is the only expressed warranty made by **Matco-Norca** and is limited to the duration of this warranty and all other expressed or implied warranties, whether implied by operation of law or otherwise, without limitation, all implied warranties of merchantability and fitness or fitness for particular purpose, are excluded under no circumstance, and in no event, will **Matco-Norca** be liable for personal injury of property damage or any other loss, damage of any kind, whether based upon warranty, contract, strict liability, negligence or any other cause of action arising in connection with the design, manufacture, transportation, installation, use or repair of the product sold by **Matco-Norca**. Buyer hereby acknowledges and agrees that under no circumstances and in no event shall **Matco-Norca's** liability, if any, exceed the replacement of the defective product(s); no additional amounts shall be made for the labor or damage resulting from the same, except as expressly set forth in this paragraph, all products and/or services provided by **Matco-Norca** and its employees and agents are provided "as is" and "with all faults".

Some states do not allow the exclusion of limitation of incident or consequential damages, so the above limitations or exclusion may not apply to you.

This warranty is void for any damage to this faucet due to misuse, abuse, neglect, accident, improper installation, any use in violation of instructions furnished by us, or any use of replacement parts other than genuine **Matco-Norca** parts.



TERMS & CONDITIONS OF SALE

Acceptance

Orders whether verbal or written, are subject to acceptance by Matco-Norca, Inc. Hereinafter referred to as the seller at its Brewster, N.Y. office. No terms or conditions of buyers order contrary to seller's terms and conditions shall be binding upon seller unless specifically agreed upon by seller in writing. Seller acceptance of orders shall occur by written acknowledgement or tender of delivery of goods and or services the subject hereof (goods) which ever shall occur first.

Prices and Sales Policy

Until written confirmation of this contract has been received by buyer, all prices are subject to change without without prior notice. We reserve the right to adjust orders orders to standard package quantities unless otherwise stated on the buyers purchase order. We reserve the right to make product improvement without notice. If seller determines buyer's credit is unsatisfactory or there is reasonable doubt concerning buyer's ability to pay, payment in advance may be required or buyer shall provide security for such payment in an amount and form acceptable to seller. Unless otherwise specified by seller, terms are 2% 10 days/net 30 days.

Taxes

All prices are exclusive of taxes and excises. Sales, use and other taxes, by whomsoever levied, are to be paid by the buyer and unless invoiced, are to be paid by the buyer direct to the appropriate governmental agency. Buyers are required to furnish seller with a copy of their tax exemption of resale certificate, otherwise applicable state sales taxes will be charged.

Delivery and Shipment of Materials

All goods are sold F.O.B. sellers warehouse. Delivery of material to a common carrier shall constitute delivery thereof to buyer and risk of loss shall pass to buyer at such time. Claims for damage to or loss of material in transit shall be filed by buyer with carrier. Buyer assumes all risks and liability for the results obtained by the use of material delivered hereunder. No claim of any kind, whether as to material delivered of for negligence or otherwise, shall be greater in amount than the purchase price of the material in respect to which such claim is made. In no event shall seller be liable for indirect or consequential damages or for anticipated profits or loss of use of equipment.

Returns and Cancellations

Permission in writing and return authorization must be obtained from seller before any goods are returned. All returns must be pre-paid, no collect shipments will be accepted. All returns made for reasons other than defects are subject to a re-stocking charge. Discontinued goods are not returnable. Cancellation of orders may be made only with the sellers written consent and shall be subject to cancellation charges.

Governing Law

The entering into, construction, interpretation, performance and discharge of the terms set forth herewith shall be governed in accordance with the laws of the State of New York.

Limited One Year Warranty

Seller warrants the material to be free of defects in material and workmanship, under normal use, proper maintenance and proper operation, for a period of one year from the date of delivery to a common carrier for shipment to the buyer or his designated agent. The obligation of the seller is limited to (1) repair of the material, or (2) replacement of any component or components proved defective in material or workmanship, or (3) refund of the purchase price.

Seller shall have no liability for the cost of removal or reinstallation with respect to any replaced or repaired product. The election of said remedies shall be determined by seller in its sole discretion and shall be considered final disposition. All implied warranties, including the implied warranties of merchantability and fitness for a particular purpose, are hereby disclaimed and excluded. This warranty is in lieu of all other warranties, guarantees, agreements and similar obligations of seller, in no event shall seller be liable for consequential or incidental damages.

Claims

No later than ten (10) days from receipt of material buyer will report, in writing, all claims for any damage, defects or shortages. All claims, including for alleged damage or defective material, shortage negligence or any other cause whatsoever "(defective performance)", shall deemed waived unless made in writing within the ten (10) day period. However, any defective performance not discoverable within said ten (10) day period (including that discoverable only in processing or in further manufacturing) shall be deemed waived unless made in writing and received by seller in writing within 90 (90) days after receipt or within ten (10) days after buyer learns of the alleged defect, which ever comes first. Seller's liability shall in no event exceed the purchased price of the material in respect to which the claim is made, or at the election of seller at its sole discretion, and to repair or replacement of such material. Seller shall not be liable for and buyer assumes all responsibility for, all personal injury and property damage resulting from handling, possession, use or resale of the material by buyer. In no event shall seller be liable for incidental or consequential damages, whether buyer's claim is in contract, negligence or otherwise. If claim is made, buyer shall permit seller at seller's option, to reinspect the material at buyer's plant or if seller so directs, buyer shall return the material at buyer's expense to seller's facility for reinspection. No material may be returned to seller without prior written permission from seller.

Force Majeure

Anything in this agreement to the contrary notwithstanding, it is expressly agreed that seller shall not be liable for any damages resulting from, and buyer shall not have the right to cancel this order because of any delays caused in whole or in part by fires, floods, windstorms, tornadoes, wars, riots, insurrections, strikes, lockouts, sit-downs, slow-ups, or other labor trouble, causing cessation or interruption of operation or by accident, material shortages, labor or fuel shortages, or inability to procure labor or materials, either on the part of the seller, or because any plant, plants or any portion thereof belonging to seller have been commandeered by the legally constituted public authority, or because any priorities or preferences established for the manufacture, assembly or allotment of materials by order, decree, or to otherwise of the United States, or by any department, bureau, commission, agent or administrator of any legally constituted public authority in any plant of seller, or any of its suppliers or resulting from any other cause beyond the control of seller.

Copyright

Copyright © 2007 Matco-Norca Incorporated. All rights reserved. No part of this catalog may be reproduced, transmitted in any form, by any means - electronic, mechanical, photocopy, recording or otherwise, without the prior written permission of Matco-Norca Incorporated. Every effort is made to present accurate information, however, Matco-Norca is not responsible for typographical errors, misprints, or updated information. All images, descriptions, model number, finishes, inner & master carton information are subject to change without notification.

OUR COMMITMENT TO QUALITY

MATCO-NORCA continues our commitment in maintaining a high standard of quality for all the products we offer. Various products in this catalog are labeled with a designated approval or certification code. Below is a brief description of these approvals.

**I.S.O. 9002
CERTIFIED**

International Standards Organization - a worldwide standards coordinating organization. An internationally recognized certification for manufacturers that comply with high standards of quality control. Developed standards ISO-9000 through ISO-9004.



International Association of Plumbing & Mechanical Officials - qualifies and lists products suitable for use in plumbing situations.



National Sanitation Foundation - a non-profit organization best known for its role in developing standards for equipment, products and services. Many standards govern products for residential use.

American Society of Sanitary Engineering - develops standards and qualifies products for plumbing and sanitary installations.



Canadian Standards Association - develops standards, tests and qualifies products used in gas lines and gas appliance installations.

Underwriters Laboratories - tests and qualifies valve and fitting products under UL standards for safety.



Factory Mutual - develops standards and qualifies products for use by the general public.

American Water Works Association - promotes public health through improvement of the quality of water. Develops standards for valves, fittings and other equipment.



American Disability Act - assures that products fully comply with the provisions of the act to ensure equal access for physically challenged users.



American Society of Mechanical Engineers - develops standards for materials and testing as well as finished products.

American Society for Testing of Materials - develops standards for materials, products, systems and services.



American National Standards Institute - organization that coordinates the work among U.S. Standards Writing Groups. Works in conjunction with other groups such as ISO, ASME, ASTM, etc.

Mechanical Standardization Society of the Valve and Fittings Industry, Inc. - a committee of manufacturers that develops technical codes and standards for the Valve & Fitting industry.

QUICK FIND INDEX

ITEM NUMBER	PAGE NUMBER	ITEM NUMBER	PAGE NUMBER	ITEM NUMBER	PAGE NUMBER
25-29		F		S	
25	48, 49	FB	37	S	20, 30, 33, 34, 35, 36
26	49-51	FCI	57	SBW	56
29	51, 52	FT	14, 18, 31	SCB	33
		FY	20, 31, 32, 37, 44, 46, 47	SCV	33
400		G		SDB	45
413	56	GH	38	SDBC	45
437	38	GS	39	SDP	45
A		H		SP	56
AC	25, 27, 28	HS	32	SS	41
AE	14, 21-29	I		SSDW	40
AG	53	IS	32	SSF	40
AIR	32	J		SST	40
AS	36	JCR	36	SSV	40
B		L		SSWM	40
B848	36	LNT	56	STMC	39
BCL	46	LSD	32	STMG	38, 39
BKT	36	LST	59	STMP	39
BSV	54	M		STMY	39
C		M	35	SW	32
CF	57	MNCE	59	T	
CFCI	57	MNFT	59	T	54
CH	32	MNJN	59	TMX	53
CICB	57	MNSN	59	TNS	16, 17, 20
CP	36	N		TRAP	58, 59
CT	13, 15, 19	NM	30	TTD	56
D		NT	59	TWB	54, 55
DDC	53	R		U	
DDF	40	RH	38	UTF	40
DE	45	RQ	31	V	
DTP	53	RT	13	VC	36
DV	36			VHW	36
				W	
				WSC	53
				WSI	53
				WTI	53
				WTS	53



Corporate Headquarters

New York
P.O. Box 27, Route 22
Brewster, NY 10509

Local: **845.278.7570**

Fax: **845-278-9056**

Toll Free: **800.431.2082**

Toll Fax: **800.640.2252**

Central Region

Texas
1150 Silber Road
Houston, TX 77055

Local: **713.680.2888**

Fax: **713.680.2999**

Toll Free: **800.935.5456**

Toll Fax: **800.683.4247**

Western Region

California
5593 Fresca Drive
LaPalma, CA 90623

Local: **714.522.1889**

Fax: **714.522.3828**

Toll Free: **866.532.8306**

Toll Fax: **866.532.8307**

Southern Region

Georgia
P.O. Box 1125,129 Crisp Drive
Americus, GA 31709

Local: **229.924.4295**

Toll Free: **800.433.7526**

Toll Fax: **800.533.5134**

MATCO-NORCA INCORPORATED

www.matco-norca.com



new york • georgia • texas • california